

Air-water systems are comprised of three main product types: passive beams, active beams, and radiant ceiling panels/sails. Even though these units are commonly referred to as “chilled” products, some may also be used for both cooling and heating. Air-water systems utilize tempered chilled water that is delivered at a supply temperature at, or above the dew point temperature of the space they serve. As such they provide sensible cooling and/or heating only and rely on the delivery of air from an air handling unit for space ventilation and humidity control.

Radiant ceiling panels were first applied to European cooling applications in the 1970’s. Northern European climates feature mild summers but often rigid winter conditions, thus their HVAC requirements are primarily heat driven. Buildings were well insulated for the rigid winter conditions and cooling seasons were relatively short so mechanical cooling was often not required. Natural ventilation provided sufficient conditioning during the summer months.

In the late 1970’s, the advent of personal computers and their peripherals resulted in additional space heat gains that made it difficult to maintain thermal comfort during summer conditions. Buildings were typically built with a slab spacing of 10 to 11 feet (3 to 3.4 m) as they did not require a ceiling plenum. Some type of heat removal system that took up very little vertical space was needed, thus the advent of radiant cooling panels. These panels integrated into a ceiling grid with lighting and other services took up very little vertical space but they were also only capable of removing heat loads of about 15 Btu/h-ft² (50 W/m²) when provided with chilled water supplied above the room dew point temperature.

As radiant cooling ceilings spread throughout Europe, it became obvious that they did not have sufficient capacity to handle sensible loads in perimeter areas where a substantial amount of glazing was employed. In the late 1980’s and early 1990’s chilled sails and passive chilled beams were developed for these applications. A typical London office building would often have radiant panels serving interior areas, supplemented by passive chilled beams or sails in areas near glazed surfaces. A raised access floor was pressurized and served as a supply plenum for an underfloor air distribution (UFAD) system that supplied air for ventilation and dehumidification purposes. Slab spacing in London was often quite tight and the combination of that and the need for the raised access floor often resulted in the use of exposed passive beams (these will be discussed in subsequent sections of this document).

Active beams were introduced in the mid-1990’s. Active beams integrate both the space air and water supply within a single terminal. After pretreatment by the air handling unit, the ducted primary air is used to create induction of room air across a sensible cooling coil integral to the terminal. Unlike passive beams, active beams can also be used for overhead heating in moderate climates.

Radiant panels and beams were introduced to the North American market around the turn of the century. Today, they are widely used in owner occupied facilities such as laboratories, healthcare, government, higher education and K-12 schools.

Chapter 1 Understanding air-water systems

The use of water as a heat transfer medium offers considerable energy savings and potentially more efficient space usage. **Figure 1** illustrates the fact that a water pipe can transport the same amount of cooling energy as an air duct two-hundred and fifty (250) times its cross sectional area! This enables the employment of air-water systems in very tight ceiling spaces for retrofit applications. It also allows for closer slab spacing in

new construction applications which can a) reduce the building structural cost, b) allow more floors to be added to a multi-story structure, c) result in greater floor to ceiling heights or d) any combination of these.

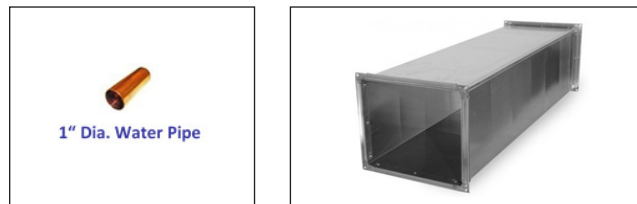
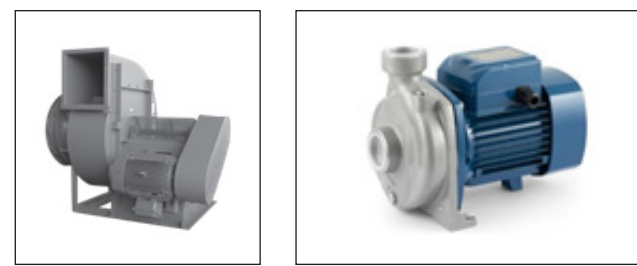

Figure 1: Cooling energy transport capacity of water versus air

In addition, the transport energy to deliver a similar amount of space cooling with air is more than six times that of doing so with water (see **Figure 2**).



$$\text{BHP} = \frac{550 \text{ CFM} = 1 \text{ ton}}{6,356 \times \text{FAN}_{\text{EFF}}} \quad \text{CFM} \times \text{SP}$$

$$\text{BHP} = \frac{4 \text{ GPM} = 1 \text{ ton}}{3,960 \times \text{PUMP}_{\text{EFF}}} \quad \text{GPM} \times \text{HD}$$

Fan BHP to move 10 tons of cooling = 5.2 Pump BHP to move 10 tons of cooling = 0.8

Assumes fan SP of 4.5 inches and efficiency of 75% Assumes head loss of 60ft. and 75% pump efficiency

Figure 2: Energy to transport cooling, air versus water

In consideration of this, air-water systems are designed to maximize the sensible cooling provided by their integral water coils while reducing space primary airflows to those which are required for proper space ventilation and latent cooling (humidity control).

BENEFITS OF AIR-WATER SYSTEMS

The use of air-water systems consistently results in numerous energy efficiency, space usage, thermal comfort and operational cost benefits. Some of these many benefits are identified below:

Space related benefits:

- Reduced primary (ducted) air requirements enable reduction of ductwork capacities and cross sections by 50% or more versus all-air systems.
- Reductions in ductwork and terminal unit size may allow reduction in new construction slab to slab spacing resulting in reduced building structural costs.
- Reduced central equipment capacities afford smaller mechanical room foot prints that can result in 5 to 15% additional usable floor space
- Beams offer easy integration into retrofit applications where space is limited.

Comfort and IAQ benefits:

- Higher supply air temperatures contribute to increased occupant comfort levels.
- Minimal airflow throttling results in less noticeable changes to room air motion, air diffusion performance and acoustical consistency within the space. Employment with a DOA (100% outside air) system ensures that consistent ventilation and space humidity levels are maintained.
- Dry-coil sensible cooling coils eliminate bacterial, fungal, or mold growth associated with fan coils and other unitary products that employ condensing coils.

Energy Efficiency and Operational Benefits:

- Using water as the primary zone heat transfer medium reduces annual transport costs by 25 to 50%.
- Modulation of zone chilled water flow rates as the first response to space cooling demand changes eliminates most primary air reheat, especially in healthcare and laboratory applications.
- Higher supply water temperatures may afford more efficient use of water side economizers and increased opportunities for free-cooling.
- Higher return water temperatures result in higher chiller operational efficiencies.
- Significant reduction in maintenance costs compared to conventional all air systems

No moving parts → no blowers, motors, damper actuators to replace
Dry-coil operation → does not require filtration

- Recommend cleaning of coils once every 4 to 5 years, more frequently in hospitality rooms where linens are frequently changed (i.e. hospital patient rooms and hotel rooms).

Chapter 2

Types of air-water terminals

Air-water systems utilize a variety of zone mounted sensible cooling devices. Radiant panels, chilled sails and passive beams are all devices used to de-couple space ventilation and latent cooling functions from its sensible cooling and/or heating requirements. These devices rely primarily on thermal stratification within the space to transfer warm air to the upper parts of the space where the devices are located. Sensible heat is extracted by convective and radiant means and absorbed into the tempered chilled water circuit serving the devices. These devices' operation has minimal effect on the room air movement within the occupied levels of the space. Their passive behavior also results in very quiet operation.

Active beams utilize the ventilation air supply from the air handling unit to create higher levels of induced room airflow across their heat transfer coils. The mixing of the primary (ventilation) and induced (room) air streams creates homogenous mixed air conditions similar to that of all-air systems. This ventilation air is also preconditioned at the air handling unit to perform all of the room dehumidification allowing the coils within the beams to perform in a non-condensing manner.

RADIANT PANELS AND SAILS

Radiant cooling panels (chilled ceilings) remove space heat by both radiant and convective means. Convective heat transfer occurs as warm air passes across their cooled surface while additional heat is absorbed by radiation from occupants and other warm surfaces within the space. In fact, the radiant exchange between the space occupants and the radiant panels allows the space temperature to typically be kept 2 to 3°F warmer while maintaining similar occupant thermal comfort.

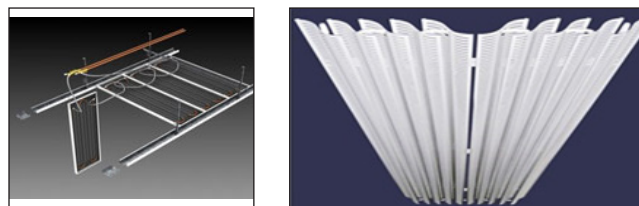

Figure 3: Chilled ceiling system and a chilled sail

A radiant ceiling panel (also known as a chilled ceiling) is, in its simplest form, a metallic ceiling tile that is fitted with chilled water piping and then dropped into an integrated ceiling support grid. Chilled water supplied at a temperature 2 to 3°F (1 to 1.5°C) warmer than the dew point temperature of the space it serves is circuited through tubes attached to the back of the panel, cooling its surface and allowing it to absorb heat from air currents moving across it as well as radiant heat sources within the space.

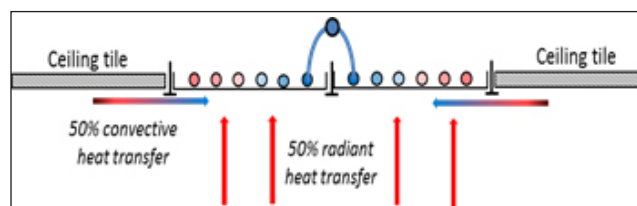

Figure 4: Radiant ceiling panel operation

Radiant panels may be constructed of either steel or aluminum. The ceiling panel is generally perforated but its free area can vary from nearly zero to as much as 30%. The chilled water tubes are arranged in a serpentine form and either fastened to the back of the panel or mounted on a carrier plate that assures consistent contact. Often times, insulation is provided on the back side of the chilled water tubes for both thermal and acoustical absorption purposes.

Radiant ceiling panels accomplish approximately half of their sensible cooling by convective exchange with the air currents moving across their surface. The remaining heat transfer occurs as a radiant exchange between the panel and warmer heat sources with the space below. Figure 4 illustrates the operation of these panels.

When used for cooling, these panels are generally capable of providing about 25 Btu/h-ft² (80 W/m²) of active panel surface, however, it is unlikely that more than 60 to 65% of the ceiling can be dedicated to active cooling panels, resulting in sensible cooling capacities between 15 and 18 Btu/h-ft² (50 to 60 W/m²), based on floor space. Any additional sensible cooling requirement would have to be supplied by the air delivery system or some other complimentary means.

Unlike most panel applications, chilled sails employ louvered shaped cooling elements that increase their effective heat transfer area and also allow room air to pass freely through them. While their heat removal capacity is greater than radiant panels, the fact that these louvers are not at a normal angle to the space occupants eliminates most of their radiant effect and does not allow the maintenance of elevated room temperatures associated with radiant panels.

Figure 5 illustrates the operation of a radiant (chilled) sail. These devices differ from radiant panels in two important ways. First of all, their heat transfer surface is greater due to the fact that they are usually louvers or of some elliptical shape arranged in a linear array with open area between them. Unlike with radiant panels, room air is allowed to pass between the heat transfer elements and recirculate back into the space, significantly increasing their convective heat transfer.

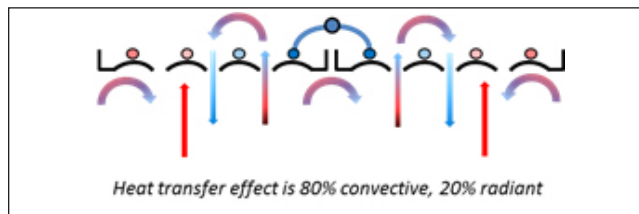

Figure 5: Operational characteristics of chilled sails

While sails provide totally sensible heat removal as high as 30 Btu/h-ft² (95 W/m²) their radiant transfer function is compromised by the fact that their surfaces are no longer perpendicular to the heat sources within the space. As a rule the heat transfer with sails is about 80% convective and only 20% radiant. As such, the elevated space temperature practice employed with radiant panels cannot be accomplished with sails. Their unusual shapes often result in a lower ceiling activation percentage.

Radiant panels and sails may also be used for heating in moderate climates.

When radiant panels and sails are used, ventilation air must be supplied to the space by a de-coupled system. The volume flow rate and dew point temperature of the supply air must also be sufficient for removal of space moisture gains in order to maintain space dew point conditions below that of the water supply to the panels and/or sails.

PASSIVE AND ACTIVE BEAMS

Active and passive beams are constructed around a water coil which drives the sensible heat transfer aspect of the system. The water coil relies on tempered chilled water, delivered at or above the dew point temperature of the space, to provide sensible cooling without threat of condensation. The building's air handling unit is tasked with the removal of a sufficient amount of moisture from the primary (ventilation) air to the space satisfy latent gains and maintain acceptable space humidity levels. Sensible heat removal by the coils reduces the sensible cooling burden of the primary air, typically resulting in primary air volume flow rates that are 60 to 80% lower than those required by all-air systems.

PASSIVE CHILLED BEAMS

A passive beam (illustrated in Figure 6) simply consists of a chilled water coil and its enclosure. Warm natural convection currents deliver room air to the upper level of the space where the beams are located. The warm air is cooled upon contact with the coil and falls back into the space, drawing warm additional warm air through the coil behind it.

Passive beams employ sensible cooling coils which have fin spacing of 4 to 6 fins per inch. They are typically delivered "chilled" water whose supply temperature (typically 57 to 59°F) is maintained above the dew point temperature of the space they serve.

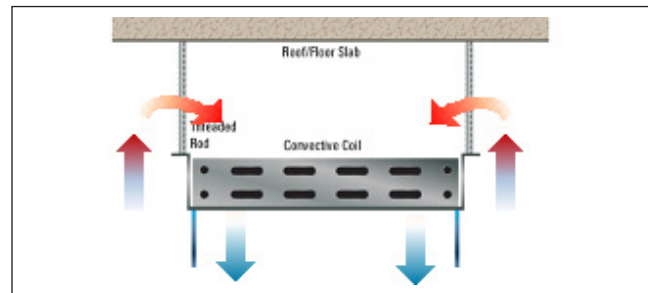

Figure 6: Passive chilled beam operation

When using passive beams, ventilation (and dehumidification) air must be introduced to the space through a de-coupled air delivery system. This delivery is often in the form of a low level displacement or underfloor air distribution (UFAD) strategy as increased space temperature gradients tend to augment the performance of the beams.

Passive beam types and configurations

Passive beams can be applied in either recessed (concealed) or exposed applications. Recessed beams are mounted above a suspended ceiling grid system and barely visible from the space itself. When applying recessed beams it is important that the beam be mounted directly above a grid module with fill material that is at least 40 to 50% free area. It is also important that an equal free area be provided within the space to allow room air to freely pass into the ceiling cavity to feed the beam.

Figure 7 illustrates a recessed beam. Note the fabric curtain that hangs freely around the perimeter of the beam. This is intended to drop onto the ceiling surface below and prevent the cool air leaving the beam from splashing out into the ceiling cavity.

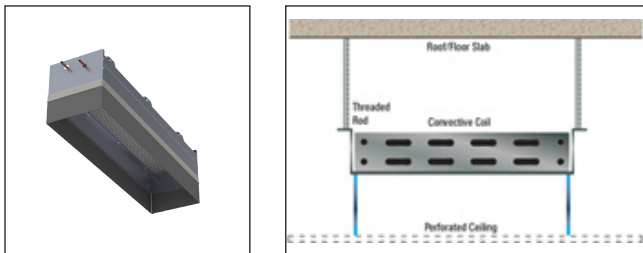

Figure 7: Recessed or concealed passive beam

When passive beams are exposed in the space (see Figure 8), their enclosure is primarily cosmetic, but it also helps to maintain even heat transfer across the coil. Exposed beams are often used in applications where reduced slab spacing does not allow for a sufficient vertical plenum to house ductwork above the usable floor space. These beams often incorporate lighting and other space services within the cabinet that houses them. When configured as such, the beams are often referred to as “multi-service” or “integrated” chilled beams.

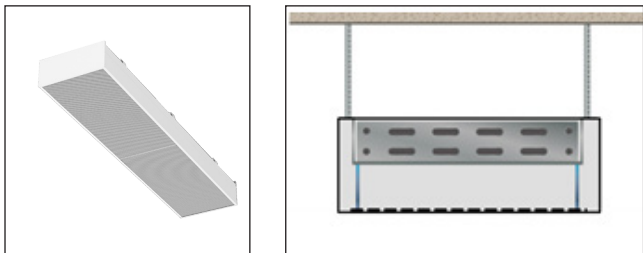

Figure 8: Exposed passive beam

Passive beam application and location considerations

In the case of all passive beams it is important that sufficient clearance be maintained above the beam to allow warm air to pass freely into the coil. The “Z” dimension in Figure 9 represents the spacing between the top of the beam and the structural surface to which it is mounted. For proper air delivery to the beam, this space should be at least 25% of the beam width (B). If the beam is recessed behind a suspended ceiling tile, the entire tile beneath the beam should be at least 30% free area and an equal free area should be provided within the space to allow room air to pass freely into the ceiling cavity and feed the beam.

The stack height (designated SH in Figure 9) can also have a significant effect on the cooling capacity of the beam. Taller stack heights give improved cooling performance. Table 1 provides performance correction guidance based on Titus catalog performance for passive beams.

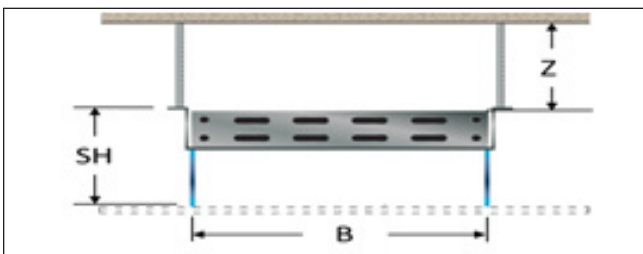

Figure 9: Important dimensional considerations for passive beams

Passive beams are also not effective for heating and therefore are most often accompanied by a decoupled heating system (fin tube, radiant panels, etc.).

Stack Height (in)	Performance data correction:	Face free area	Performance data derate
8	Subtract 6%	30%	Subtract 6%
10	None	40%	Subtract 2%
12	Add 5%	50% or more	None

Table 1: Corrections for other stack heights and discharge free areas

The following recommendations apply to passive beam location and application.

- Passive beams should not be mounted higher than fifteen (15) feet above the floor
- Beams with cooling capacities more than 250 Btu/h-lf should not be mounted directly above stationary occupants
- Exposed chilled beams should employ chilled water delivered at or above the dew point temperature of the space in which they reside
- Recessed beams should employ chilled water supply temperatures that are at least 2°F above the dew point temperature of the space they serve

Passive beam cooling capacities and limitations

Passive beams are generally capable of providing space sensible cooling up to 350 Btu/h-lf, depending upon their width. Their cooling is highly dependent upon the temperature differential between the ambient air around them and their mean chilled water temperature. The entering air temperature for most exposed beam applications may be 2 to 3°F warmer than the control temperature of the room they serve. While the mean water temperature varies depending on the cooling load, it can generally be assumed as 2°F warmer than the supply water temperature entering the coil. Most manufacturers’ catalog data assumes an 18°F (10°C) temperature differential. Table 2 suggests correction factors for other differentials.

Actual ΔT	10	12	14	16	18	20	22	24
Correction Factor	0.56	0.67	0.78	0.89	1.00	1.11	1.22	1.33

Table 2: Correction factors for varying temperature differentials

Certain applications will result in passive beam entering air temperatures that are several degrees higher than that within the room. For example, applications with UFAD systems where passive beams are mounted directly above glazing may result in entering air temperatures 5 to 8°F higher than the control temperature of the space they serve. Passive beams serving such applications may be capable of providing as much as 500 Btu/h-lf of sensible heat removal.

ACTIVE BEAMS

Like their passive counterparts, the coils within active beams utilize tempered chilled water supplied at or above the space dew point temperature to provide sensible cooling only. Active beams (see Figure 8) receive and transfer pretreated (ventilation) air from the air handling unit to the space. Using the ventilation air to pressurize a plenum with aerodynamically designed discharge nozzles, high velocity jets of air are created induction of room air over the water coil integral to the unit.

Forced induction dramatically improves the cooling capacity over passive beams and radiant products and also allows the coils to provide space heating in moderate climates. Active beams generally utilize a constant volume flow of air into the space while

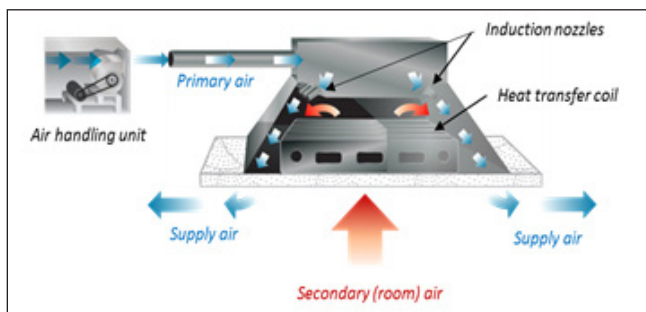

Figure 10: Active beam operation

varying its cooling or heating delivery temperature by allowing the zone thermostat to throttle the water flow rate through the coil, however, their primary air delivery can also be modulated in response to space occupancy when demand control ventilation (DCV) is applied.

Several important terms that will be used to describe the operation of active beams are defined below.

- **Primary air** is the pretreated air delivered to the beam through its ducted air connection.
- **Secondary (or entrained) air** is that which is induced through the return face and coil within the beam
- **Supply air** is the mixture of primary and reconditioned secondary air that is discharged to the space
- **The induction ratio** of an active beam is defined as the volume flow rate of its induced (room) airflow divided by the volume flow rate of the primary air ducted to it
- **COPA** is the beam coil's sensible cooling output per CFM of primary air it is supplied. This ratio will be used to express the efficiency of the beam's water side cooling function.

Figure 11 illustrates the performance of active chilled beams. Active chilled beams may induce four (4) or more parts of room air for every one part of primary air that is ducted to them. This induction ratio will depend upon the nozzles employed by the manufacturer and/or specified by the user. Generally speaking, smaller nozzles create higher induction and COPA ratios but limit the beam's primary airflow rate. Larger nozzles produce lower beam operational efficiencies but allow for higher primary airflow rates and usually result in the need for fewer beams. Further discussion of the induction ratio and COPA will be presented in the active beam selection section that follows.

When supplied with conventional primary air temperatures (53 to 55°F) chilled water coils within active beams are usually capable of removing 60 to 80% of the space sensible heat gain, reducing the sensible cooling burden on the primary air accordingly. This makes these systems ideal for applications like healthcare and heat driven laboratories where strict ventilation (outdoor) rates create serious mismatches between the required air delivery rate and space thermal comfort demands. When drastic reductions in the primary airflow rate are applied, however, care

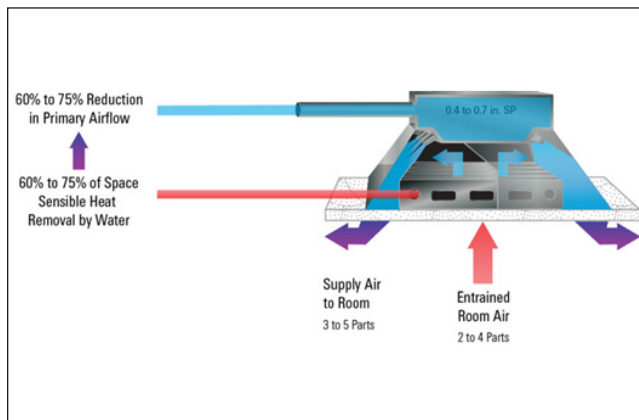

Figure 11: Performance characteristics of active chilled beams

must be taken to assure that the primary airflow rate can still adequately ventilate and dehumidify the space. Additional discussion regarding beam system primary airflow rates is presented in the airside design section that follows.

Types of active beams

Active beams can generally be classified according to space mounting and location requirements or application specific features they incorporate. *Titus is proud to offer the industry's widest offering of active beam solutions.*

Most active beams are integrated into a suspended ceiling grid system and thus their facial dimensions and features are tailored to coordinate with the applied grid system. Figure 12 illustrates several active beams that are intended for such applications. The CBAL-24 features a (nominal) two foot wide face while the CBAL-12 has a one foot (nominal) width. Both series are available in one or two slot versions and with either a perforated metal or linear aluminum bar grille return section face. Both series are available in lengths from two to ten feet. The CBAL-24 features the highest cooling capacities of all Titus active beams. A similar model two foot wide model (CBLV) is available in 2, 4, 6 and 8 foot lengths and incorporates twin vertical coils with condensate trays and a float switch for applications where periodic condensate could occur.

The CBAM is a modular beam available in 2 and 4 foot (nominal) lengths and is always provided in a nominal two foot width. These beams feature a four way discharge pattern and are ideal for use in smaller office spaces and examination rooms in healthcare facilities.



Figure 12: Active beams for use with suspended ceiling grid systems

The CBAL-12 and CBAL-24 beams shown in Figure 12 can also be modified for exposed mounting applications without ceilings. These variants (CBLE-12 and CBLE-24, respectively) are provided with discharge extension wings

designed to produce “Coanda” effects that assure horizontal discharge, preventing unwanted “dumping” of cool air into the occupied zone.

Figure 13 illustrates other active beam types that are designed for mounting in or near the ceiling. The CBAV is designed to mount above a drywall ceiling or soffit adjacent to the building façade. It induces plenum air through its vertical coil, reconditions it, mixes it with primary air and then discharges it through a linear diffuser or grille into the space. As the induced air path originates above the ceiling, only the narrow supply outlet is visible from the space, creating a clean linear appearance that architects often prefer. A continuous linear outlet may also be provided where the CBAV terminal simply drops over sections of the supply outlet and the remainder of the outlet is blanked off or used for return air purposes.

The CBAV is also available with a condensate and float switch that shut off the zone water supply in the unlikely event condensation should occur.



The CBAB shown in Figure 13 is designed for integration in a drywall soffit

Figure 13: Active beams for perimeter mounting in or near ceiling

in applications like hotels and domiciliary facilities. The CBAC offers the same features and performance of the CBAB but is furnished in its own cabinet for exposed mounting below the ceiling. It can also be provided with security features that allow application in detention and psychiatric treatment facilities.

Figure 14 illustrates active beam versions that are designed for sidewall and sill (under window) mounting applications. The CBAW is intended for high sidewall mounting and can be provided with security features for detention and psychiatric treatment facilities. The CBAS is designed for retrofitting old high pressure induction terminals and as such may be customized upon application.

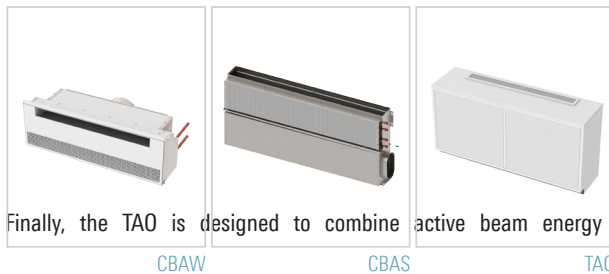

Finally, the TAO is designed to combine active beam energy and

Figure 14: Active beams for sidewall and floor mounting

maintenance qualities with the superior contaminant removal capabilities of displacement ventilation. TAO terminals mount under the window in educational applications and assure consistent displacement ventilation of the space throughout both cooling and heating seasons. Their superb acoustical qualities (NC less than 30) also assure a quiet and productive learning environment.

Integrated service beams

Integrated service beams (also referred to as “multi-service beams”) are designed to incorporate other space services within their housing. These services often include the following:

- 1) Lighting (down and/or up-lighting) and controls
- 2) Occupancy detection
- 3) Smoke detection
- 4) Audio services

Titus Ventus Lux series are active beams that incorporate LED lighting and may also be fitted with other services. VLR models (shown in Figure 15) are designed to integrate with suspended grid ceilings. They are quite popular for use in applications such as hospital patient rooms where ceiling space is very limited. Use of the VLR enables both the HVAC and lighting services to share the same ceiling space.

VLP series beams are designed for continuous pendant mounting in open space applications. Their modern design and shape creates an ambience that is attractive to architects. They are furnished with LED space lighting and can also be provided with up-lighting to further enhance the aesthetics of the indoor environment.



VLR SERIES



VLP SERIES

Figure 15: Titus VENTUS LUX integrated service beams

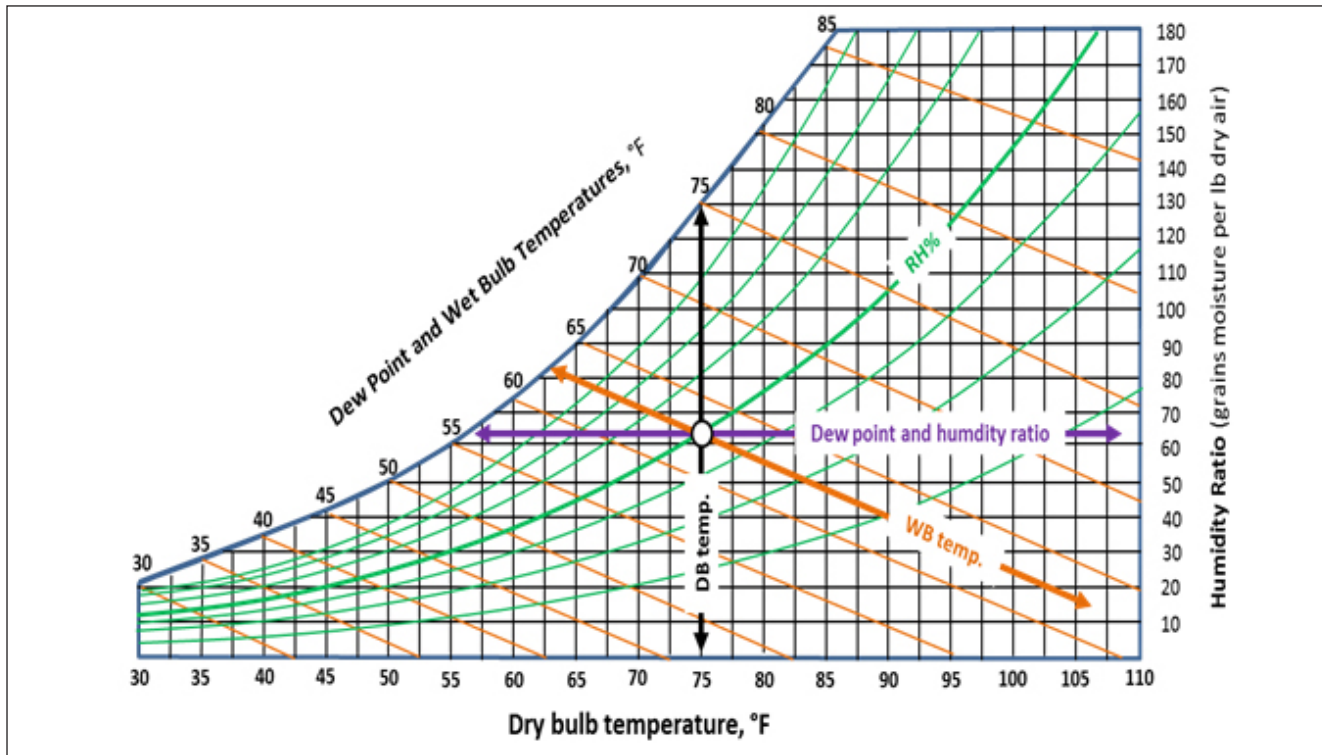

Figure 16: Psychrometric chart

Chapter 3 Psychrometrics and thermal comfort basics

One of the major elements affecting thermal energy transfer and occupant comfort is the space humidity level. Psychrometrics use thermodynamic properties to analyze conditions and processes involving moist air. A detailed study of can be found in Chapter 1 of ASHRAE 2013 Fundamentals Handbook. This section is a brief overview of psychrometric processes and how they can best be applied to maximize space comfort and air-water system performance.

Atmospheric Air (the air that we breathe), contains many gaseous components including water vapor and contaminants. *Dry Air* is atmospheric air with all moisture removed and is used only as a point of reference. *Moist Air* is a combination of dry air and water vapor and is considered equivalent to atmospheric air for this discussion.

A psychrometric chart is a graphical representation of the thermodynamic properties of moist air. There are several charts available to cover all common environmental conditions at various altitudes. The simplified one in **Figure 16** illustrates conditions of 30 to 110°F at sea level.

PSYCHROMETRIC TERMS RELEVANT TO AIR-WATER SYSTEM DESIGN

Dry-bulb temperature (T_{DB}), is the temperature of air that may be measured using a standard thermometer. It can also be referred to as sensible temperature.

Wet-bulb temperature (T_{WB}) is measured using a 'wetted' thermometer. The combination of the dry and wet-bulb temperature of an air mixture can be used to determine its moisture content.

Relative Humidity (RH) is the moisture content of an air mixture expressed as a percentage of that corresponding to fully saturated air at the same dry bulb temperature. The room air relative humidity level for optimum space comfort is 30-35% for heating conditions, and 45-60% for cooling conditions.

Absolute humidity (W) is the vapor content of an air mixture. It is described in terms of "lbs. moisture per lbm-dry air" or "grains of moisture per lbm-dry air" (where there are 7,000 grains of moisture per pound of water). It may also be referred to by the terms moisture content or humidity ratio.

Dew Point Temperature (T_{DP}) is the temperature below which vapor begins condense and separate from the air. It is also known as the saturation temperature and corresponds to an air mixture that is at 100% relative humidity.

Specific Volume (\square) is the reciprocal of air density and is described in terms of cubic feet per pound of dry air (ft³/lbm-da). An increase in air temperature will result in a decrease in density and an increase in its specific volume. A decrease in atmospheric pressure (that generally accompanies an increase in altitude) will decrease air density while increasing its specific volume. Higher altitudes require larger motors and blowers to move the same effective mass, due to this related increase in specific volume.

Enthalpy (h) is the total heat content within an air mixture. Enthalpy is dependent on both the dry-bulb temperature and moisture content of the air and is described in terms of Btu/lbm.

Once two of the aforementioned properties of the air have been defined, values for all of other properties can be obtained from the psychrometric chart.

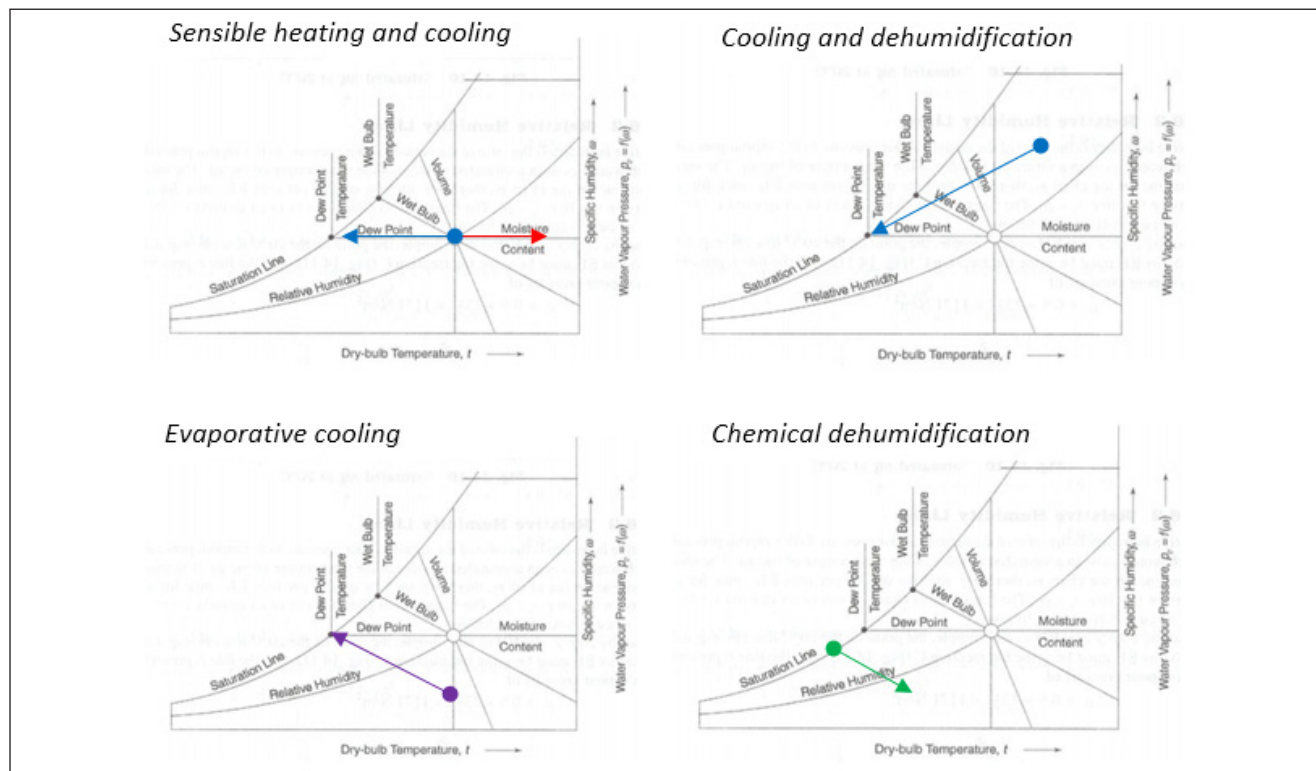

Figure 17: Common psychrometric processes

PSYCHROMETRIC PROCESSES IN AIR-WATER SYSTEMS

Four important psychrometric processes performed by HVAC systems illustrated in Figure 17 are discussed below.

Sensible heat transfer processes

The diagram on the upper left side of Figure 17 illustrates sensible heat transfer processes. Shown as a horizontal path drawn from left to right on the psychrometric chart, sensible heating is a process that raises the dry-bulb temperature of air without changing its moisture content. Conversely, sensible cooling is the removal of heat without affecting the absolute humidity (W) or dew point temperature of the air mixture and is represented on the chart as a horizontal path moving from right to left. It should be noted that sensible cooling and heating processes do affect the relative humidity of the air mixture.

Latent cooling (dehumidification) processes

Latent cooling processes occur both within the air handling unit and the room itself.

- Latent processes are shown as vertical paths on a psychrometric chart. Humid air introduced into the air handling unit is usually cooled to a dry-bulb temperature well below its dew point in order to lower both its dry-bulb temperature and its moisture content before delivery to the space. This process is referred to as cooling and dehumidifying and is illustrated in Figure 17.
- A second latent cooling process occurs within the space as the relatively dry airstream is introduced to room air with higher moisture content. The drier air absorbs moisture from the

room air as it passes through the space in order to maintain the desired room humidity level. This is not only important to maintaining thermal comfort but also to assuring that condensation does not form on the beams or other surfaces.

- Most latent cooling processes also involve sensible heat transfer, resulting in angled or diagonal paths on the psychrometric chart. These include not only the cooling and dehumidifying process within the air handling unit but also evaporative cooling.

Chemical dehumidification

In order to maximize their primary airflow rate reduction, air-water systems applied in humid climates are often supplied by dedicated outdoor air handling units that are fitted with desiccant dehumidification provisions. These often involve the use of a rotating wheel with a solid core made of materials (activated alumina, silica gels, zeolites, etc.) that are able to adsorb moisture from the supply air stream after it leaves the cooling/dehumidifying coil and transfer it to the lower RH exhaust air stream. The process (shown in the lower right diagram of Figure 17) occurs at a relatively constant enthalpy and wet bulb temperature and results moisture transfer from the supply to exhaust air in exchange for sensible heat transferred to the supply air stream. These air handling units will be further discussed in the Air-water System Design section that follows.

Table 3 summarizes the psychrometric processes illustrated in Figure 19. Each process is tied to the air mixture properties it affects. Note that sensible heat processes have no effect on the moisture content (dew point temperature or humidity ratio) of the mixture but do affect changes to the wet bulb temperature, the relative humidity, enthalpy and specific volume of the mixture. All of these properties are tied to the dry air content within the mixture.

Psychrometric process	Temperatures			Humidity levels		Heat content and density	
	Dry bulb	Wet bulb	Dew point	Humidity ratio	Relative Humidity	Enthalpy	Specific volume
	T _{DB}	T _{WB}	T _{DP}	W	%	h	
Sensible heating	increases	increases	no change	no change	decreases	increases	increases
Sensible cooling	decreases	decreases	no change	no change	increases	decreases	decreases
Cooling and dehumidication	decreases	decreases	decreases	decreases	increases	decreases	decreases
Evaporative cooling	increases	little change	increases	increases	increases	little change	little change
Chemical dehumidication	increases	little change	decreases	decreases	decreases	little change	little change

Table 3: Effect of psychrometric processes on air mixture content

THERMAL COMFORT BASICS

ASHRAE Standard 55-2017 Thermal Environmental Conditions for Human Occupancy analyzes the factors that contribute to occupant thermal comfort and establishes comfort guidelines for indoor occupancy. The Standard defines the occupied zone (see figure 18 below) as “the region normally occupied by people within a space, generally considered to be between the floor and 6 ft. level above the floor and more than 3.3 ft. from outside walls/ windows or fixed heating, ventilation, or air-conditioning equipment and 1 ft. from internal walls.” The space from the interior walls inward 1 ft. serves as a mixing zone where room air is entrained into the supply air jet and mixes to provide thermal comfort in the occupied space. The Standard also **leaves the designation of the occupied zone height** to the designer as most commercial HVAC applications involve stationary occupants that are primarily seated. In that case, the height of the occupied zone is often considered to be 42 inches or 1.1 m.

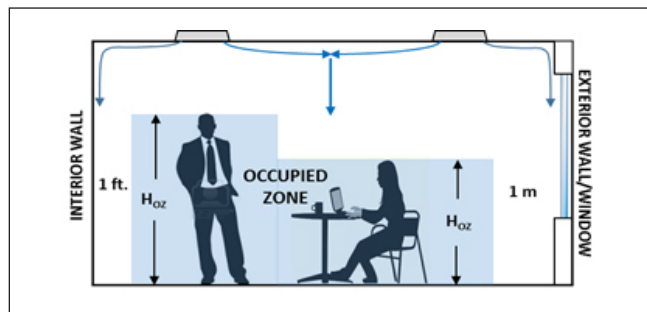

Figure 18: ASHRAE Standard 55-2017 definition of occupied zone

The Standard also establishes a range of operative temperature and space humidity conditions that is expected to provide good thermal comfort for 80% of the population. Those conditions are illustrated in Figure 19 below. The comfort window is bounded by an upper humidity limit that corresponds with a space dew point temperature of 62°F (there is no lower limit regarding humidity levels) and operative temperatures between 66 and 78°F. The parallelogram shape of the window discourages the use of cooler temperatures with low space humidity levels and higher temperatures with high space humidity levels. There is about a 2°F variance along the upper and lower operative temperature boundaries.

Other factors that affect occupant comfort include:

- Occupancy metabolism levels
- Clothing levels
- Air speed
- Space vertical temperature gradients

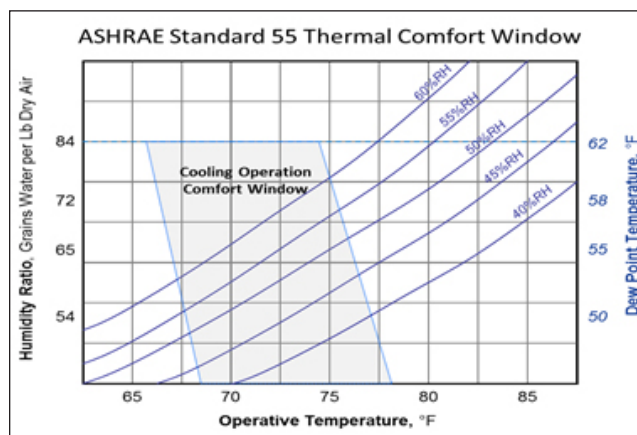

Figure 19: ASHRAE Standard 55-2017 thermal comfort recommendations

Chapter 4 Air-water system applications

Air-water systems can be successfully installed and operated anywhere the indoor humidity can be controlled. The zone sensible cooling components (panels, sails and/or beams) operate within the conditioned space and with only a few exceptions can rely on the central air handling unit to deliver ventilation air at a sufficiently depressed dew point temperature and volume flow rate to control the humidity of the space within which they operate. Identical to all-air systems, outdoor air is cooled and dehumidified at the air handling unit before being introduced into the space. The key difference between the two systems is that sensible cooling by the coils within the air-water devices allows the flow rate of air delivered to the space to be significantly reduced from that with all-air systems that rely on the ducted airflow to accomplish all of the space sensible cooling.

Chilled beam systems have been successfully applied in every North American climate zone. They have also been used in most every non-residential building type but particularly in:

- Laboratories
- Healthcare facilities
- Educational facilities (both K-12 and higher education)
- Government facilities
- Office buildings

Radiant panels, sails and chilled beams are often used where vertical space is at a premium. They are also frequently used in LEED certified buildings.

The ideal applications for active beam systems are those where overriding ventilation requirements conflict with the ability to cool or heat the occupied space. This is particularly the case with laboratories and healthcare facilities which will be discussed in further detail in the sections that follow.

Active beams for laboratory applications

Laboratories are energy intensive applications using up to six times more energy than average buildings. Strict ventilation and exhaust regulations employed to assure occupant health and safety. The use of chemicals and gases within the space also prohibits recirculation of the exhaust air and thus demands that 100% outside air is supplied to the space. Conflicts between the ventilation and sensible cooling demands lead to widely conflicting airflow rates and reheat requirements to balance the two.

Laboratory spaces can usually be classified as either air or heat driven applications. Air driven applications include laboratories whose minimum air change rate is established by their general ventilation air requirements or by the summed exhaust airflow rate of the fume cabinets within them. The latter sub-category ventilation rates (12 to 15 ACH⁻¹ or more) typically exceed that required for space sensible and latent cooling. In this case, the ventilation air is often supplied at an elevated supply air temperature to prevent overcooling.

Other air driven laboratories' ventilation rates are determined by industry standards that range from four to eight air changes per hour (ACH⁻¹). In addition, laboratories where chemicals and gases are used cannot recirculate their return/exhaust air and are thus subject to supply 100% outside air.

In many cases the treatment of sensible heat gains within the space with an all-air system requires considerably more supply air than the ventilation rate. The presence of electronic equipment on the benches and tissue preservation refrigerators often result in space sensible heat gains of up to 60 Btu/h-ft². All-air solutions delivering air 20°F cooler than the room would require an airflow rate of 2.7 CFM/ft² (around 16 ACH⁻¹) to accomplish that amount of sensible cooling. This is 3 to 4 times the required space ventilation rate. Although variable air volume systems are able to reduce the airflow rate during periods that require less sensible cooling, they can only reduce their airflow to the mandated ventilation rate before reheat of the supply air must be initiated.

Active beams are an ideal solution for these heat driven laboratories. The term COPA introduced earlier refers to the active beam coil's sensible cooling output per CFM of primary air that is delivered to the beam. Active

beam coils are typically capable of removing anywhere between 30 and 60 Btu/h of sensible heat for every CFM of primary air ducted to the beam. Primary air delivered cooler than the room also contributes to the sensible cooling capacity of the beam according to the following equation:

$$\text{Primary air sensible cooling capacity (SCC}_{PA}) = 1.1 \times (T_{ROOM} - T_{SUPPLY})$$

Thus primary air delivered 20°F below the room temperature has a sensible cooling capacity (SCC_{PA}) of 22 Btu/h-CFM which is additive to the active beam's COPA. For example an active beam with a COPA of 55 supplied by primary air 10°F cooler than the room (SCC_{PA} of 11) has a total sensible cooling capacity of 66 Btu/h per CFM of primary air, three times that of an all air system delivering air 20°F cooler than the space its serves. Conversely active beams are capable of removing the same amount of sensible heat as an all-air system operating at three to four times the airflow rate.

Active beams can also be used to eliminate reheat (typically 20% of HVAC energy use) in laboratories with more moderate sensible heat gains. Primary air at or near room temperature can be employed without changing the COPA of the beam's coil. The resultant sensible heat removal will then be equal to the beam's COPA or 30 to 60 Btu/h-CFM. This results in a sensible cooling capacity of up to 40 Btu/h at a primary airflow rate of 4 ACH⁻¹ (or 0.67 CFM/ft²) while completely negating the need for reheat as the sensible cooling delivery can be throttled to zero simply by shutting off the chilled water flow to the beams.

Active beam systems have shown energy savings of 40 to 70% when applied to heat driven laboratories. In addition, first costs are usually less as the air handling units and ductwork sizes are significantly reduced.

Active beams in healthcare applications

Healthcare facilities are also intensive energy users. On average, they consume 2.5 times the energy as average commercial buildings. HVAC services are a major source of energy consumption in hospitals, often representing 60 to 70% of the building's total energy use. Some 40% of the HVAC energy (see Figure 20) is expended through parasitic reheat that is required to balance the actual space conditioning demand in patient rooms to the excess cooling that results from high space ventilation requirements.

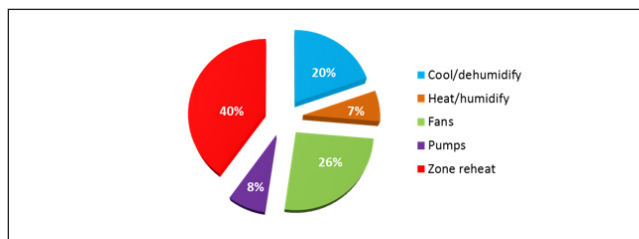

Source: ASHRAE AEDG-50 for large hospitals, 2012 averages for climates zones 3A, 4A and 5A

Figure 20: HVAC energy use in hospitals

Up until 2013, ventilation rates for hospitals were legislated by the Facilities Guidelines Institute (FGI). The regulations provided that a minimum of 6 ACH⁻¹ be delivered to the patient room at all times. Of this, 1/3 (or 2 ACH⁻¹) had to be outside air. The same air volume was extracted from the space and a portion of that mixed with outside air at the air handling unit and recirculated to the spaces it served. A MERV-14 filter was required on the discharge of the air handling unit. Recirculation within the same room was allowed but not factored into the air change requirements.

Up until now, hospitals had typically employed all air constant volume or variable volume terminals with reheat coils to serve patient rooms. Space sensible loads above 22 Btu/h-ft² could be conditioned while maintaining the minimum 6 ACH-1 with air delivered 20°F below the room temperature. When the space cooling demand dropped below 22 Btu/h-ft², reheat had to be employed to offset the excess cooling that was being supplied at the 6 ACH-1 minimum ventilation rate. As the space demand continued to drop, more and more reheat was required.

In an effort to reduce hospital energy use, ASHRAE Standard 170-2013 *Ventilation of Healthcare Facilities* made some significant changes to patient room ventilation requirements. Among these were the following:

- 1) *The number of total room air changes was reduced from six to four. Neither the outside air change rate (2 ACH⁻¹) nor the air handling filtration requirement (MERV-14) were changed.*
- 2) *Recirculation within the same space could count toward the non-outside air changes*
- 3) *Room recirculation devices that use dry coils do not require filters*

The changes that were adopted support decoupling of the space sensible cooling in order to significantly reduce the amount of parasitic reheat needed to balance the space ventilation requirements and its sensible cooling demand. Decoupling space sensible heat gains can also reduce central fan energy when room air recirculation opportunities are leveraged.

Active beams are the choice solution for accomplishing this decoupled sensible cooling. Sensible cooling by their integral heat transfer coil can remove most or all of the sensible cooling burden from the primary air source and afford control of the space cooling delivery by modulating the chilled water flow through the beams. The following example illustrates the use of active beams in a patient care room.

Example 1:

Figure 21 illustrates a 250 square foot patient room (total volume of 2,500 ft³) whose design sensible and latent cooling loads are 20 Btu/h-ft² and 3.5 Btu/h-ft² respectively. The room is to be maintained at 75°F and a relative humidity of 55% (W = 72 grains). The required outside airflow rate (2 ACH⁻¹) is calculated to be 84 CFM. Since all of the space latent cooling is also to be provided by the pretreated outside air which is delivered at a humidity ratio (W) of 53 grains, the airflow rate required for latent cooling can be calculated as follows:

$$CFM_{LAT} = q_{LAT} / (0.69 \times \Delta W) = (250 \times 4) / (0.69 \times 19) = 76 \text{ CFM}$$



Figure 21: Patient room used in example 1

In order to satisfy the space sensible cooling requirement of 5,000 Btu/h with 84 CFM of primary air, total sensible cooling rate of 60.2 Btu/h-CFM would be required. In order to minimize reheat, as much of the design sensible cooling as possible should be provided by the coil within the beam. If primary air is delivered at 75°F, or room neutral, the coil within the beam is responsible for all of the sensible heat removal. Chilled water is supplied at 59°F in order to assure that the chilled beam coil remains dry.

Titus chilled beam selection software indicates that a single eight foot CBAL-24 with B2 nozzles can accomplish the entire design sensible cooling of the space with a chilled water flow rate of 1.5 GPM. As the space cooling demand drops, the water flow rate through the coil is simply reduced accordingly while the primary airflow rate remains constant.

Had an all-air VAV solution providing 55°F supply air been employed, the design airflow rate would have required 250 CFM (6 ACH-1) and the system airflow rate would have only been capable of reducing its sensible cooling delivery by 33% (coincident with the 4 ACH-1 minimum ventilation rate) before reheat became necessary to balance the cooling delivery with the space sensible cooling demand.

Passive beams for UFAD applications

Underfloor air distribution (UFAD) is often used as a compliment to raised access floor (RAF) systems in buildings where frequent relocation or reconfiguration of space services is required. This might include actual relocation of furniture and/or occupants but may also relate to technological upgrades that require that power, voice and/or data services must be easily accessed.

Underfloor air distribution is an attractive compliment to RAF systems. By pressurizing the floor cavity and utilizing as a supply air plenum, the flexibility of the raised floor platform can be expanded to include the HVAC service as well. Supply air outlets are located within in the access floor tiles and can be easily relocated by moving the tile within which they are mounted. The use of floor mounted diffuser also affords the occupants of the space more individual control of their thermal environment as most of the supply outlets afford easy manual adjustment of their discharge airflow rate.

There are certain challenges that must be considered when designing UFAD systems. The plenum must be well sealed in order to make sure the supply air is evenly distributed and to allow the plenum pressure to be adequately controlled. The use of the structural slab as the lower boundary of the supply air plenum may also result in considerable heat transfer effects that may not be accounted for when planning perimeter area sensible cooling strategies.

Perimeter area design sensible cooling requirements (35 to 40 Btu/h-ft²) are often as much as three times those encountered in interior spaces due to solar and external heat gains. In addition, natural convection currents that accompany the solar heat gains results in limited thermal stratification in these areas.

UFAD systems typically introduce air to the floor plenum near the mechanical core of the floorplate they serve (see Figure 22). Cool air discharged into the plenum cavity encounters heat transferred through the slab from warm return air passing below it. Underfloor ductwork or distribution pathways, often referred to as "air highways" contain the conditioned supply air through much its travel distance in order to defer the slab heat transfer effects until it is discharged into the open floor plenum.

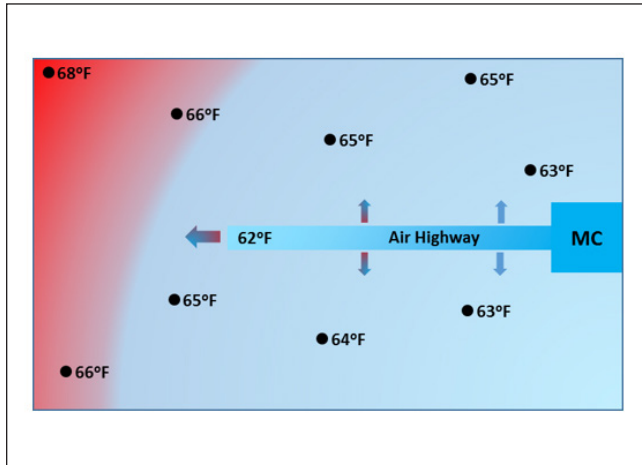

Figure 22: Effects of UFAD slab heat transfer

Once in the plenum the supply air drifts slowly across the slab until it reaches the perimeter of the building. As it moves, it picks up heat and which can result in supply air temperature rises as much as 5 to 7°F. Although interior area UFAD cooling airflow rates are similar to those of overhead mixing systems (0.5 to 0.6 CFM/ft²), the combination of the diminished temperature differentials and limited stratification can result in perimeter airflow rates that are 2 to 3 times that required with a ducted overhead system delivering air at a 20°F temperature differential!

Passive chilled beams can be used to minimize UFAD perimeter area supply airflow rates. Figure 23 illustrates a passive beam mounted adjacent to the glazing in a perimeter office. Warm air travels naturally up the glazing and enters the passive beam at 80 to 83°F. The momentum of the convective air stream drives the air through the beam, which can remove up to 500 Btu/h-lf of sensible heat as it passes.

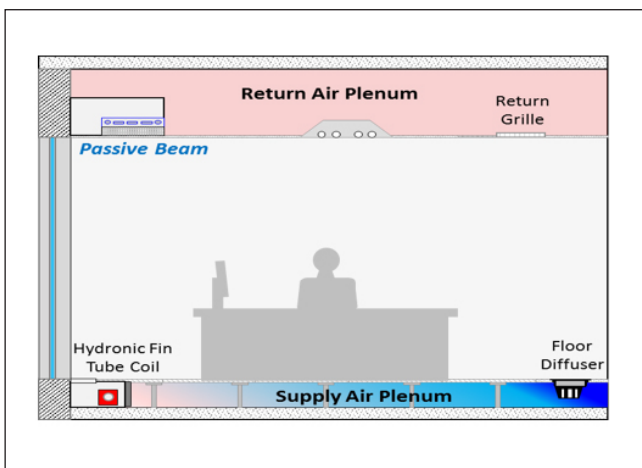

Figure 23: Passive chilled beam used in UFAD perimeter zone application

Floor diffusers must be utilized to satisfy the zone ventilation and dehumidification requirements, but the passive beam is responsible for the removal of 75 to 90% of the space sensible heat gains, thus the discharge temperature of the supply air is not critical to providing space sensible cooling. Supplementing the space sensible cooling with passive beams has allowed plenum airflow rates to similar levels (0.5 to 0.6 CFM/ft²) as that required for interior spaces, resulting in 50 to 60% reductions in the total airflow rate of the UFAD system.

When passive beams are utilized, perimeter heating is often accomplished using trench type fin tube heating elements. Figure 24 below illustrates such a system. The supply air plenum is recessed 1.5 to 2 feet from the building façade and fin tube heating elements are intermittently placed within the unconditioned space below the access floor. A continuous linear grille spans the perimeter, delivering heat up the glazing above the active heating elements and allowing room air to fall into the gaps between the elements to provide make-up air.

One of the other issues prevalent to UFAD systems is the potential overcooling of interior spaces. All-air UFAD systems operating with a single plenum inevitably lower interior area plenum and discharge air temperatures in order to condition perimeter zones. Leakage of this air around floor service boxes and through the RAF itself can often cause thermal discomfort. The decoupling of perimeter sensible cooling loads with passive beams allows interior supply air temperatures and/or plenum pressures to be reset independent of the perimeter area sensible cooling demand, eliminating the need for cold interior area discharge temperatures.

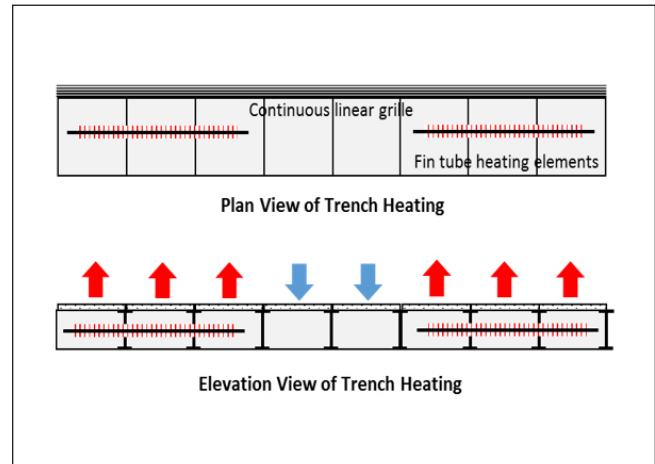

Figure 24: UFAD trench hydronic heating system

Chapter 5 Air-water system design

Chilled beam and radiant ceiling systems are designed to handle moderate to high thermal loads in the space. They are also an effective solution in spaces where individual temperature control is desired. Ideal applications are spaces where the sensible heat ratio is greater than 0.85, meaning that 85% or more of the total heat gains in the space are sensible. These applications include laboratories, healthcare, educational facilities, hotel guest rooms, libraries, and museums.

Use of chilled ceiling systems should be limited to applications where sensible cooling loads are less than 25 Btu/h-ft². Although the panels themselves are capable of more, their employment in more than 70% of the ceiling plane limits their effective sensible cooling capacity. They are often complimented by passive beams in perimeter areas which can contribute up to 300 Btu/h-lf of space sensible cooling. When placed directly above the perimeter glazing, passive beam sensible cooling outputs can exceed 500 Btu/h-lf. Additional sensible cooling (and all of

the space latent cooling) may be contributed by the decoupled ventilation air delivery that is required with radiant ceilings and passive beams. While radiant ceiling panels can be used to deliver some heat to the space, they are usually provided with separate perimeter heating system, especially in colder climates.

Active beams can comfortably supply as much as 80 Btu/h-ft² of sensible cooling to the space and can provide overhead perimeter heating capacities similar to that of all-air systems.

Practical Design Guidelines

There are certain guidelines that should be followed when designing air-water systems to ensure a safe and comfortable environment for occupants and achieve optimal energy efficiency.

- The system should be designed to meet the cooling and, if tasked, heating requirements of the space they serve. Overdesigning the system will increase the cost of the project, and can also result in compromised occupant comfort levels.
- Primary air must be adequately dehumidified, and supplied at a flow rate sufficient to offset the space latent loads. This flow rate must also be high enough to meet the ventilation requirements as outlined in ASHRAE standard 62.1 or by other applicable regulatory agencies.
- Chilled beams and radiant ceiling systems are effective and efficient HVAC systems and should be considered for any application where indoor humidity levels can be adequately controlled. They should not be applied in spaces where indoor dew point levels of 60°F or less cannot be maintained. This would include kitchens, bathrooms, and some retrofit applications in humid climates.
- Condensation detection/prevention controls should be considered for areas like lobbies, entrances and rooms with operable windows where excessive infiltration can occur.
- Beams and radiant panels are best applied when installed no higher than 14 feet above the floor, but active beams may remain effective with installation heights up to 20 feet. When installed at or above these heights it should be for cooling only applications as it is difficult to project warm air down this far.
- When heating with active beams, entering water temperatures should be maintained as low as possible to in order to meet the space heating requirements while facilitating the use of high efficiency boilers.
- Systems should be designed to take full advantage of free cooling and heating opportunities through economizers and heat recovery devices. Chilled beams and radiant panels are highly efficient products that facilitate energy savings within the conditioning (chillers, boilers) and transport equipment (air handlers, fans and pumps) of the HVAC system.
- Surface temperatures maintained below the room dew point temperature (TDP), may cause condensation to form. In order to prevent any possible condensation, the chilled water supply temperature to the coil should be maintained at or above the operating room dew point temperature. If this is not possible,

an additional thermal barrier or other condensation prevention strategies may be required.

Design Methodology

The design of chilled ceiling and beam systems is a process that involves configuration of the central refrigeration, heating and air handling equipment to most efficiently serve the various zone conditioning and ventilation needs. Equipment selection should focus on combining an efficient HVAC service delivery, while maintaining a safe and comfortable environment for the building occupants.

The primary criteria that affect chilled beam system design and operation are:

- 1) Space design criteria
 - a) Space sensible heat gains and losses
 - b) Space latent heat gains
 - c) Space ventilation airflow rates
- 2) Room and primary air design conditions
 - a) Dry bulb temperature
 - b) Moisture content
- 3) Zone primary airflow rates and operating pressures
- 4) Water delivery requirements
 - a) Entering water temperatures
 - b) Water flow rates
 - c) Coil pressure drops

The following sections provide guidance toward defining and designing around these governing criteria.

Establishing the space design criteria

The first step in the beam system design process is the determination of space cooling (sensible and latent) and heating loads and minimum ventilation airflow rates (see [Figure 25](#)). Guidance regarding assignment of specific sensible and latent heat gain values to various space heat sources is available in the 2013 ASHRAE Handbook Fundamentals. A number of commercially available load calculation programs quantify space heat gains (and losses) according to sensible and/or latent component values and aid in the calculation of individual room cooling and heating loads. It is imperative that **only the individual space sensible loads and dehumidification are considered when selecting chilled ceilings and beam components** as all of the outdoor and recirculation air pre-treatment is provided at the air handling unit.

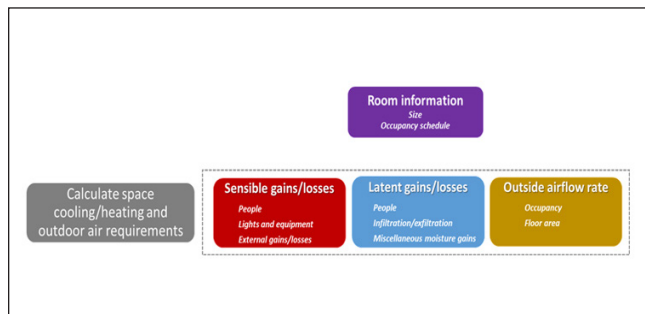

Figure 25: Defining space cooling, heating and ventilation requirements

Guidelines for determining the minimum ventilation requirements are given in ASHRAE standard 62.1-2013. These airflow requirements are based on the space size and the number of occupants it houses. Rates also vary according to space utilization. Healthcare facility ventilation rates are established by ASHRAE Standard 170 while laboratory ventilation rates are “recommended practices” proposed by numerous regulatory agencies.

The next step in the design process is defining room temperatures for heating and cooling and establishing a maximum allowable room dew point temperature. This should be done according to guidelines set in ASHRAE Standard 55-2017 and guidance regarding space heating and cooling practices presented in the 2015 ASHRAE Handbook Applications. Note that during actual system operation, the maximum allowable dew point temperature will only be approached during wet-bulb design conditions which represent a very small percentage of the system’s operational time. It will also rarely be approached in perimeter areas where high sensible heat gains require primary airflow rates higher than the minimum required for space humidity control.

Establishing room, primary air and water design conditions

Air-water systems are usually designed to maintain the space dew point temperature between 55 and 58°F which corresponds to a relative humidity of 50 to 55% when the room temperature is 75°F. Unlike all-air systems where the space sensible cooling demand almost always determines their required airflow delivery, the maintenance of a slightly higher space dew point temperature can often significantly reduce the amount of primary air that must be delivered to the space when air-water systems are applied (see section below).

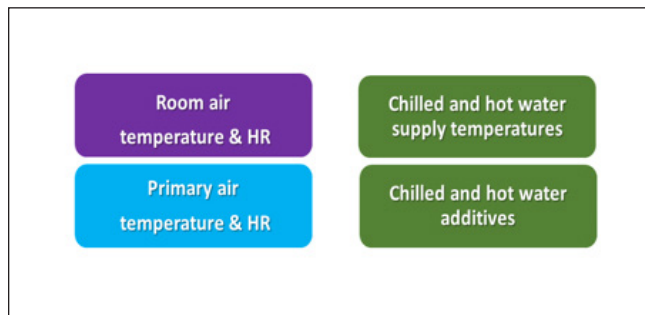

Figure 26: Establishing room, primary air and water design conditions

At this point the primary (ventilation) air temperature can be identified. Primary air is often delivered warmer during heating operation because the outside air is much drier and little if any moisture must be removed at the air handling unit. Raising the primary air temperature during heating operation also reduces burden on the space heating source. The minimum primary air temperature for cooling operation should be at within 3°F of the room dew point temperature. If lower primary air temperatures are employed, care should be taken to insulate any beam surfaces that are exposed to the ceiling plenum. Using primary air temperatures that approach the room design temperature will reduce or eliminate reheat requirements but will result in the need for more beams as the chilled water circuit will be responsible for more sensible heat removal. Primary air temperatures for cooling operation are generally selected between 55 and 60°F.

Determining space primary airflow rates

When decoupled sensible cooling is applied, the responsibilities of the primary air delivery must be clearly defined.

- The primary air is *solely responsible* for the proper ventilation of the space
- The primary air is *solely responsible* for the removal of moisture from the space
- The primary air contributes to the sensible cooling of the space in that it a) drives the beam’s induction function and b) when delivered cooler than the space the primary air compliments the sensible cooling provided by the coil within the beam

For proper and safe operation of the system, a primary (or decoupled system) airflow rate must be maintained that is capable of fulfilling all of the functions identified above. At a minimum, the primary airflow rate must accomplish the ventilation and moisture removal functions identified above. The objective of a good beam system design should be to tailor the beam selection to provide the required space sensible cooling with a primary airflow rate that is as close as possible to that required to accomplish the other functions.

In most air-water system applications, the space latent cooling demands usually define the primary airflow rates. The space design dew point temperature thus often has a major effect on the energy efficiency of a chilled beam system as the primary airflow rate must be capable of providing sufficient space humidity control.

Corrections for altitude

When HVAC systems are designed for use in higher altitude locations, their performance must be corrected for the dry air conditions that correspond to that altitude. Altitude not only affects the density of the air within the mixture but also its moisture and heat retainage capabilities. ASHRAE’s 2013 Handbook Fundamentals provides the following equation to establish a correction factor for air density at altitudes (in feet) other than sea level:

$$F_{\text{ALTITUDE}} = [1 - (\text{altitude} \times 6.8754 \times 10^{-6})]^{5.2559}$$

Altitude correction factors should be applied to correct the primary air CFM required for a given amount of sensible and latent heat removal.

Titus air-water system selection software allows the user to input the altitude at which the equipment is to operate and makes all of the necessary altitude corrections when calculating beam performance.

The primary airflow rate required to provide a given amount of space sensible cooling is calculated as:

$$\text{CFM}_{\text{SENS}} = Q_{\text{SENS}} / [1.085 \times (T_{\text{ROOM}} - T_{\text{PA}})]$$

The primary airflow rate required to satisfy the space latent cooling demand is calculated as:

$$\text{CFM}_{\text{LAT}} = Q_{\text{LATENT}} / [4,840 \times (W_{\text{ROOM}} - W_{\text{PA}})]$$

if absolute humidity is expressed in lbs. H2O/lbm-da, or

$$\text{CFM}_{\text{LAT}} = Q_{\text{LATENT}} / [0.69 \times (W_{\text{ROOM}} - W_{\text{PA}})]$$

if absolute humidity is expressed in grains H2O/lbm-da

The primary airflow rate should thus be corrected for altitude using the appropriate equation:

$$\text{CFM}_{\text{SENS@ALT}} = \text{CFM}_{\text{SENS}} \times F_{\text{ALTITUDE}}$$

and

$$\text{CFM}_{\text{LAT@ALT}} = \text{CFM}_{\text{LAT}} \times F_{\text{ALTITUDE}}$$

Primary airflow rates must always be maintained at the minimum determined for proper space ventilation and humidity control. In most applications, beams can be selected that are capable of providing the required space sensible cooling at those same primary airflow rates but higher primary airflow may be necessary when high sensible cooling loads are encountered.

Designing with slightly higher room RH levels (for example 55% instead of 50%) can significantly reduce the amount of primary airflow to satisfy the room latent loads as the airflow rates are inversely proportional to the differential between room and primary air humidity ratios (W).

For example, consider a classroom with a latent cooling load of 6,000 Btu/h being served by primary air with a humidity ratio (W_{PA}) of 54 grains/lb.-da. If the room is to be maintained at 75°F and 50% RH, the room humidity ratio (W_{ROOM}) is 65 grains/lb.-da. The primary airflow rate required to maintain the design room humidity level can be calculated as follows:

$$\text{CFM}_{\text{PA}} = \frac{Q_{\text{LATENT}}}{0.69 \times (W_{\text{ROOM}} - W_{\text{PA}})} = \frac{6,000}{0.69 \times (65 - 54)} = 790 \text{ CFM}$$

Had a room RH of 55% ($W_{\text{ROOM}} = 72$ grains/lb.-da) been allowed while the primary air humidity ratio (W_{PA}) remained at 54 grains/lb.-da, the required primary airflow rate for latent cooling becomes:

$$\text{CFM}_{\text{PA}} = 6,000 / [0.69 \times (72 - 54)] = 483 \text{ CFM}$$

Both room conditions are well within the thermal comfort requirements of ASHRAE Standard 55-2017 *Thermal Environmental Conditions for Human Occupancy*. Figure 27 illustrates the differences in the two room humidity levels and the impact of raising the room RH to 55%.

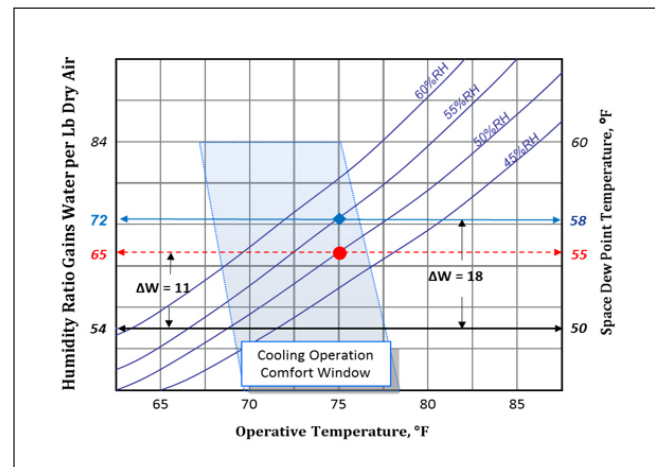

Figure 27: Impact of designing to a slightly higher room relative humidity

When room humidity levels cannot be sufficiently raised, the use of a dedicated outdoor air system (DOAS) air handling unit with a secondary desiccant wheel may be required to lower the primary air humidity ratio to a level similar to the space ventilation airflow requirement. The passive desiccant wheel can lower the primary air's humidity ratio by 6 to 10 grains/lb.-da while increasing its dry-bulb temperature by 6 to 10°F. This reduces the primary airflow rate required to provide space latent cooling while increasing the sensible cooling burden on the chilled water system. Additional information on this type of air handling unit may be found in Chapter 8 ASHRAE Standard 55-2017 *Thermal Environmental Conditions for Human Occupancy*.

Determining beam system chilled and hot water supply temperatures

The entering chilled water temperature should be selected to avoid condensation. This means the temperature of the heat transfer surface, either water coil or panel/sail surface, must be higher than the dew-point temperature of the space air passing over it. In order to achieve maximum cooling capacity the entering chilled water temperature should be as low as possible. Chilled water supplied at or above the space dew point temperature will assure that condensation does not form on the surfaces of the beam.

Entering hot water temperatures are not usually critical to proper operation of the beam but should be selected according to the requirements of the boiler supplying them. It is sound practice to employ hot water temperatures below 120°F when active beams are used for overhead heating. The discharge temperature from the beam should also be maintained within 15°F of the room control temperature in order to prevent excessive stratification which can compromise the system's zone ventilation effectiveness. Table 6.2.2.2 of *ASHRAE Standard 62.1-2016 Ventilation for Acceptable Indoor Air Quality* awards a zone ventilation effectiveness (EZ) to overhead heating when supplied within 15°F of the room while exceeding that differential reduces the EZ value to 0.8.

If either the chilled or hot water in the system supply water loops contain glycol, the diminished heat transfer effect must be considered when estimating coil sensible heat transfer capacity.

Titus chilled beam selection software automatically corrects beam performance for glycol additives in various concentrations specified by the user.

Once the space primary airflow rates and water supply temperatures have been established, the beam selection process can begin.

Chapter 6 Selecting and Locating the Beams

After all of the above design requirements have been tentatively established, the beams and/or ceiling panels selection follows.

Matching active beam types to their common applications

Table 4 matches types of active beams to the applications where they are often used.

Application	Specific Areas of Use	Common Active Beam Mounting Location	Commonly Used Beam Type(s)	Titus Model Type(s)
Healthcare facilities	Patient rooms	Ceiling grid integration	Active, linear or modular type	CBAL-24, CBAM, VLR*
		Under window	Active, displacement type	TAO
	Examination rooms	Ceiling grid integration	Active, modular type	CBAM
	Laboratory areas	Ceiling grid integration	Active, linear type	CBAL-24, CBAM, VLR*
		Exposed, non-continuous	Active, linear type	CBLE-24
	Exposed, continuous	Active, linear type	VLP*	
Office areas	Ceiling grid integration	Active, linear or modular type	CBAL-24, CBAM, VLR*	
Lobbies and waiting rooms	Ceiling grid integration	Active, linear or modular type	CBAL-24, CBAM, VLR*	
Educational facilities	Classrooms	Ceiling grid integration	Active, linear or modular type	CBAL-24, CBAM, VLR*
		Under window	Active, displacement type	TAO
	Laboratory areas	Ceiling grid integration	Active, linear type	CBAL-24, CBAM, VLR*
		Exposed, non-continuous	Active, linear type	CBLE-24
	Exposed, continuous	Active, linear type	VLP*	
Office areas	Ceiling grid integration	Active, linear or modular type	CBAL-24, CBAM, VLR*	
Meeting areas	Ceiling grid integration	Active, linear or modular type	CBAL-24, CBAM, VLR*	
Research facilities	Classrooms	Ceiling grid integration	Active, linear or modular type	CBAL-24, CBAM, VLR*
		Under window	Active, displacement type	TAO
	Laboratory areas	Ceiling grid integration	Active, linear type	CBAL-24, CBAM, VLR*
		Exposed, non-continuous	Active, linear type	CBLE-24
Exposed, continuous	Active, linear type	VLP*		
Offices	Ceiling grid integration	Active, linear or modular type	CBAL-24, CBAM, VLR*	
Office buildings	Open office areas	Ceiling grid integration	Active, linear or modular type	CBAL-24, CBAM, VLR*
		Exposed, continuous	Active, linear type	VLP*
	Private offices	Ceiling grid integration	Active, linear or modular type	CBAL-24, CBAM, VLR*
	Conference rooms	Ceiling grid integration	Active, linear or modular type	CBAL-24, CBAM, VLR*
	Perimeter areas	Ceiling grid integration	Active, linear or modular type	CBAL-24, CBAM, VLR*
	Lobby areas	Ceiling grid integration	Active, linear or modular type	CBAL-24, CBAM, VLR*
Exposed, continuous		Active, linear type	VLP*	
Hotels, dormitories and apartments	Guests (bed) room areas	Soffit mounted	Active, linear type	CBAB, CBAC
	Restaurant areas	Ceiling grid integration	Active, linear or modular type	CBAL-24, CBAM, VLR*
	Lobby / atrium areas	Ceiling grid integration	Active, linear or modular type	CBAL-24, CBAM, VLR*
	Meeting rooms	Ceiling grid integration	Active, linear or modular type	CBAL-24, CBAM, VLR*

Table 4: Common active beam applications

- 1) For office space and healthcare applications, 2-way or 4-way ceiling mounted beams are widely preferred. The flexibility provided due to their multiple size and nozzle configurations, allow them to be efficiently applied in most applications.
- 2) Classroom and patient room applications often employ displacement chilled beams due to their superior acoustics and contaminant removal capabilities. Their low sidewall location also enables them to supply static heat to the space during unoccupied hours while the air handling unit is not operating. Ceiling based beams may also be used in classrooms but should be employed with a decoupled static heating system if it is desired to maintain unoccupied heating without operation of the air handling unit. Additional information regarding these applications is provided in Chapter 4.
- 3) Small spaces such as dormitories, apartments and hotel rooms may employ 1-way discharge active beams that are sidewall or soffit mounted. Their discharge is typically directed towards the outside wall, especially when both warm and cool air is delivered by the beam.

Other considerations may determine the model and size of the beams to be used:

- 1) Available beam and ductwork mounting locations
- 2) Direction and throw of supply air discharge for thermal comfort consideration
- 3) Space acoustical constraints
- 4) Ceiling services coordination

General beam selection considerations

Water flow rates should be selected to minimize pressure drop, while maintaining turbulent flow through the product. In order to assure turbulent flow through the coils, water flow rates should be maintained at or above 0.25 GPM per circuit. Water velocities within the coil should not exceed 4 FPS in order to prevent water velocity noise. Coil water pressure drops should generally be limited to 10 ft. H₂O or less.

The recommended airside pressure operating range for active chilled beams is typically between 0.25 and 0.75 inches of water (gauge). The

use of excessive operating pressures in active beam systems will directly impact the beam's noise generation.

Although active beam lengths in one foot increments are available, the integration of these beams into suspended ceiling grids will usually dictate that beam lengths in two foot nominal increments (e.g. 2, 4, 6 and 8 foot) be used. The number of beams employed may also be affected by the geometry of the space. For example, even though five (5) four foot long beams might be capable of providing sufficient cooling for a 20 x 20 foot room, six (placed in a 2 x 3 matrix) would likely be preferred in order to provide symmetry to the architectural appearance of the ceiling.

In general, chilled beam systems should be designed to minimize the primary airflow volumetric flow rate. This is done by relying on chilled (and hot where applicable) water as much as possible for removal of the space sensible heat gains. Oftentimes minimizing the primary airflow rate involves the use of small nozzles and thus greater numbers and/or lengths of beams.

Nozzle configuration, the engine that drives active beam performance

The nozzle within an active chilled beams largely determine their heat transfer efficiency. It is the type and placement of these nozzles that drives the entrainment of room air across the beam's heat transfer coil. Most manufacturers of active beams use very similar heat transfer coils therefore differences in beam performance are largely attributable to the manufacturers' nozzle design.

Like most manufacturers, Titus offers several nozzle configurations for each of its active beam models. These nozzles are very small, varying in diameter from 0.134 to 0.307 inches in diameter. Two slot beam models utilize between 20 and 24 of these nozzles per linear foot of length while on slot beams utilize half that number. Titus nozzles are all stamper and drawn into a bell mouth shape.

While all of the nozzle types are located on the same centerline spacing, the smaller nozzles are capable of creating greater room air induction ratios. In fact the smallest nozzle (B1) available on CBAL-24 beams has an induction ratio of 5.9 while the largest (B4) nozzle's induction ratio is only 2.5.

Nozzle Size	Small (B2)			Medium (B3)			Large (B4)		
Beam Nominal Length	4ft	6ft	8ft	4ft	6ft	8ft	4ft	6ft	8ft
Primary airflow, CFM/LF	9.0			20.0			30.0		
COPA, BTU/H-LF	76.0	72.4	69.0	43.4	40.7	38.4	28.6	26.9	25.4
CoilQ _{SENS} BTU/H-LF	684	652	621	868	814	768	858	807	762
Total cooling, BTU/H-LF	882	850	819	1,308	1,254	1,208	1,560	1,467	1,422

Includes primary air contribution where $T_{ROOM} - T_{PA} = 20^{\circ}F$

Table 5: Cooling performance of various active beam nozzle types

Table 5 illustrates the effect of the nozzle configuration on three lengths of CBAL-24 linear active beams. The primary airflow capacities are based on an inlet static pressure of 0.5 inches H₂O and the chilled water flow rate is in all cases 1.0 GPM. Note that the COPA (sensible cooling per CFM of primary air delivered to the beam) is highest in the case of the smallest (B2) nozzle and lowest for the largest (B4) nozzle. However, the primary airflow capacity of the larger nozzle is over three times that of the smallest nozzle resulting in a higher coil sensible cooling capacity.

When the sensible cooling contribution of the primary air (delivered 20°F below the room temperature) is added, the beam with the larger nozzle is capable of delivering almost 75% more sensible cooling on a per linear foot basis. This comes at the expense of more fan energy and outdoor air conditioning. Reheat requirements will also be higher as the coil is only providing 55% of the space sensible cooling where the coil in the beam with small (B2) nozzles is providing over 75% of the space sensible cooling. This means the zone cooling output can be reduced by 75% by simply shutting off the chilled water supply to the coil. The beam with the larger nozzle would only be able to reduce its cooling capacity by 55% by shutting off its chilled water supply.

Active beam selection and sizing

The primary objective in selecting active beams is to reduce the airflow rate for space sensible cooling to that required for space ventilation or latent cooling, whichever is greater. In almost all cases, the airflow rate for latent cooling will be higher than that required to ventilate the space.

Chilled beam selection thus starts by determining the minimum primary airflow rate (see Figure 28) required to ventilate and dehumidify the space. In order to calculate the airflow rate for latent cooling, the space latent heat gains and the room primary air humidity ratios must be identified. In order to determine the primary airflow rate for space ventilation, the space use, area and occupancy should be identified. ASHRAE Standard 62.1 includes tables that set population and area ventilation rates dependent on the space use. It also prescribes ventilation correction factors and calculations

for correcting these values based on zone and system effectiveness.

It should be noted that the room air humidity ratio also determines its dew point temperature which is necessary for establishing the zone minimum chilled water supply temperature (must be kept at/or above the zone dew point temperature).

Once the minimum primary airflow rate and chilled water supply temperature has been established, the beam selection process begins. Figure 29 illustrates the process. First the beam type and configuration 1) to be used is established. This determines the relationships between the beam's primary airflow rate, its airflow performance (noise generation and inlet pressure requirement) and perhaps most importantly its induction capabilities. The beam's room air induction capacity and chilled water supply temperature can then be estimated 2) at varying chilled water flow rates to establish the coil's sensible cooling output 3) (and calculate its sensible cooling efficiency or COPA). The sensible cooling contribution 4) of the primary air (SCC_{PA}) can also be calculated and added to the coil contribution to estimate the 5) total sensible cooling rate (Btu/h-CFM_{PA}) delivered by the beam.

The space design sensible heat gains 6) is then divided by the beam's sensible cooling rate (Btu/h-CFM_{PA}) 5) to determine the primary airflow rate 7) (CFM_{SENS}) that is required by the beam (at the defined operating conditions) to supply the required space sensible cooling. This airflow rate 7) is then compared to the minimum airflow rate required for latent cooling and ventilation 8) and the greater of the two values is established as the beam's primary airflow rate 9).

Applications with high sensible heat loads may prohibit lowering primary airflow rates to this level but the objective should still be to lower the primary airflow rate as much as is practically achievable.

As one can see, the selection of an active beam is a process of trial and error. While the calculation of the minimum airflow rate for space latent cooling and ventilation is relatively simple, balancing the airflow rate

B

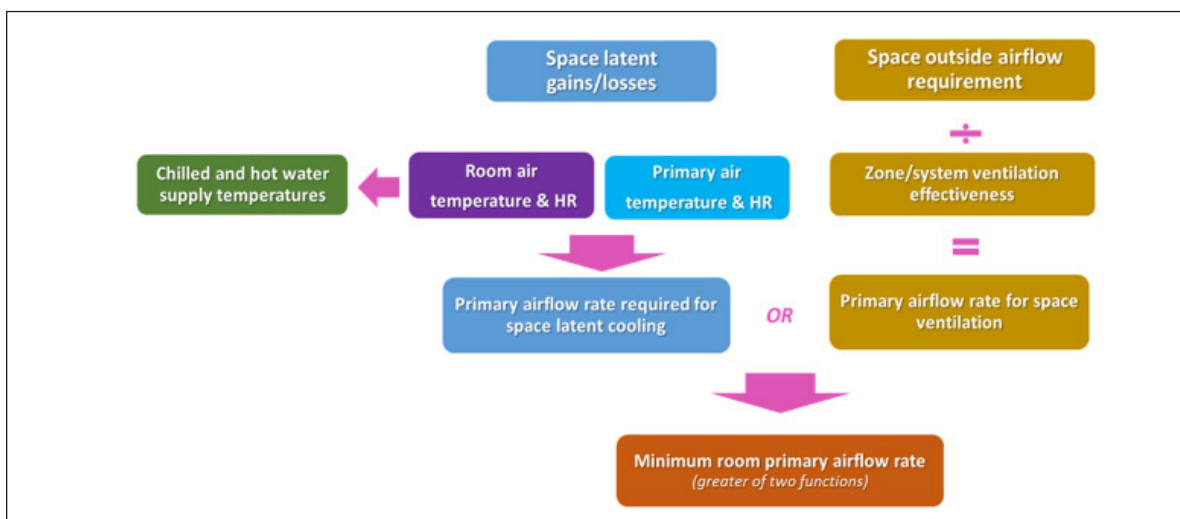

Figure 28: Identifying zone minimum primary airflow rates

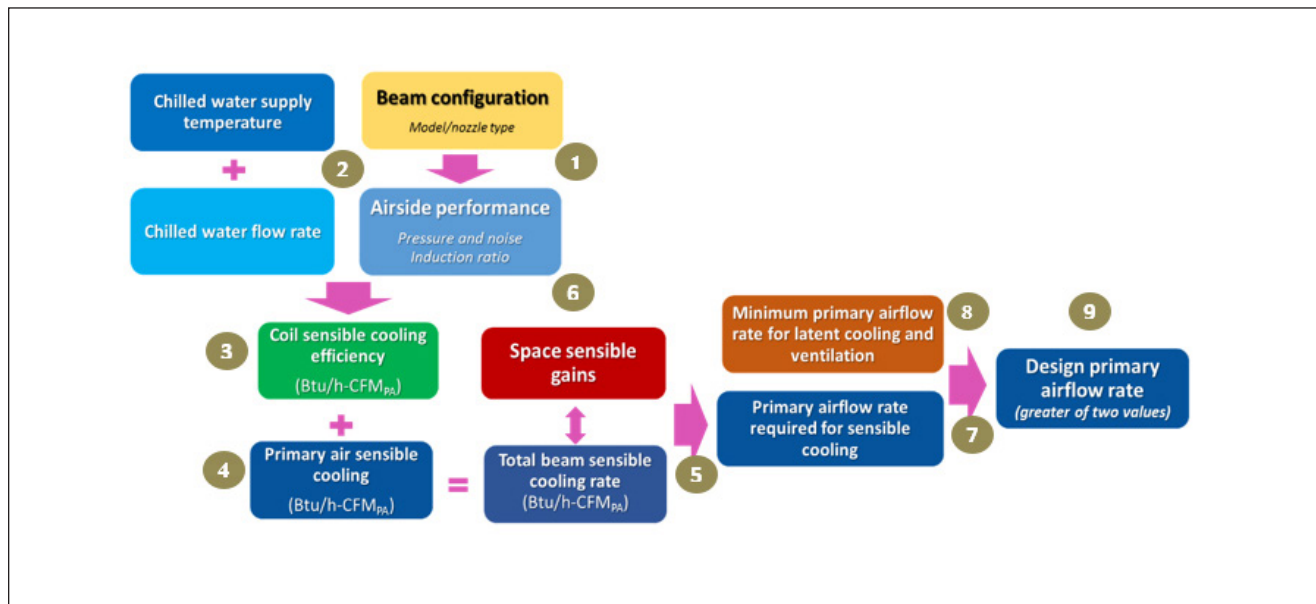

Figure 29: Process of determining zone primary airflow rate

for sensible cooling involves multiple variables. The following examples illustrate the active beam selection process.

Example 2:

Active beams are to be used to condition a 2,000 ft² interior zone of an office building. The space sensible and latent design cooling loads are 12 Btu/h-ft² and 2 Btu/h-ft² respectively. There are 18 occupants within the space. The room is to be kept at 75°F and 50% RH (W = 65 grains, dew point temperature of 55.1°F) and primary air will be supplied at 55°F and 54 grains. Determine the beam selection using CBAL-24 linear chilled beams assuming a zone ventilation effectiveness of 1.0 and a system ventilation effectiveness of 75%.

Solution:

The minimum ventilation requirement of the space is calculated in accordance with ASHRAE Standard 62.1 as 5 CFM/person plus 0.06 CFM/ft².

$$CFM_{VENT} = R_p \times \# \text{ Occupants} + R_A \times \text{Area} = 5 \times 18 + .06 \times 2,000 = 210 \text{ CFM}$$

This value must then be corrected for the system ventilation effectiveness:

$$CFM_{VENTCORR} = 210 / 0.75 = 280 \text{ CFM}$$

The primary airflow rate for latent cooling is calculated as:

$$CFM_{LAT} = q_{LAT} / [0.69 \times (W_{ROOM} - W_{PA})] = 4,000 / (.69 \times 11) = 527 \text{ CFM}$$

If the space sensible cooling (24,000 Btu/h) is to be done at 527 CFM of primary air (the CFM required for latent cooling), the selected beams must produce a total sensible cooling rate of 45.5 Btu/h-CFM_{PA}. In order

to provide good room air distribution, the beams will be limited to at least one beam per 250 ft² of area, thus a minimum of 8 beams each with a (minimum) primary airflow rate of 67 CFM will be preferred.

Per Titus' selection software, four foot CBAL-24 beams with B4 nozzles are capable of providing 3,046 Btu/h of sensible cooling when supplied 67 CFM of primary air and 0.5 GPM of chilled water at 57°F. When the combination of eight such beams are considered, their total primary airflow rate of 527 CFM is capable of providing 24,368 Btu/h of sensible cooling. Their total sensible cooling capacity is thus 46.2 Btu/h-CFM_{PA}.

Example 3:

Active beams are used to condition a 900 ft² perimeter zone of an office building consisting of six individual offices (150 ft², one occupant each). There must be one beam per office and its length cannot exceed 6 feet, nor its NC exceed 30. The space sensible and latent design cooling loads are 40 Btu/h-ft² and 4 Btu/h-ft² respectively. The room is to be kept at 75°F and 50% RH (W = 65 grains, dew point temperature of 55.1°F) and primary air will be supplied at 55°F and 54 grains during cooling operation.

The beams are also tasked with heating and the design heat loss of the zone is 18,000 Btu/h. During heating conditions, the room is to be maintained at 70°F and primary air will be supplied at 60°F. The beams are to be four pipe and supplied chilled water at 57°F and hot water at 110°F.

Determine the beam selection using CBAL-24 linear chilled beams assuming a zone ventilation effectiveness of 1.0 and a system ventilation effectiveness of 70%.

Solution:

The minimum ventilation requirement of the space is calculated in accordance with ASHRAE Standard 62.1 as 6 CFM/person plus 0.06 CFM/ft².

$$CFM_{VENT} = RP \times \# \text{ Occupants} + R_A \times \text{Area} = 5 \times 6 + .06 \times 900 = 84 \text{ CFM}$$

This value must then be corrected for the system ventilation effectiveness:

$$CFM_{VENTCORR} = 84 / 0.7 = 120 \text{ CFM}$$

The primary airflow rate for latent cooling is calculated as:

$$CFM_{LAT} = q_{LAT} / [0.69 \times (W_{ROOM} - W_{PA})] = 3,600 / (.69 \times 11) = 474 \text{ CFM}$$

If the space sensible cooling (36,000 Btu/h) is to be done at 474 CFM of primary air (the CFM required for latent cooling), the selected beams must produce a total sensible cooling rate of 76 Btu/h-CFM_{PA}, thus 6 beams with a (minimum) primary airflow rate of 80 CFM would be the preferred cooling solution.

There is no solution which allows the sensible cooling to be performed at the minimum (80 CFM) primary airflow rate and within the NC30 constraint. The closest solution would be to employ six foot CBAL-24 (four pipe) beams with B3 nozzles, each capable of providing 6,000 Btu/h of sensible cooling when supplied 90 CFM and 1.9 GPM of 57°F chilled water

When selecting the beams for heating, the cooling effect of the primary air delivered 10°F below the room temperature must also be considered. This cooling effect is calculated as follows and then added to the zone heat losses to establish the required beam coils' heating capacity.

$$q_{PA} = 1.1 \times CFM_{PA} \times (T_{ROOM} - T_{PA}) = 1.1 \times (6 \times 90) \times (70 - 60) = 5,940 \text{ Btu/h}$$

thus the actual zone water side heating requirement will be 23,940 (5,940 + 18,000) Btu/h.

The same (six) beams selected for cooling can provide the required water side heating using 0.5 GPM of 110°F hot water. Thus the zone primary airflow rate will be 540 CFM and the zone chilled and hot water flow rates will be 7.6 and 3.0 GPM, respectively.

The primary airflow rate in this example was determined by the zone sensible cooling requirement and is about 12% higher than that which was required for space latent cooling. It should be noted however that an all-air solution would have required three times more (1,635 CFM) primary air to deliver the same design sensible cooling! Had the all-air solution incorporated VAV control, the primary airflow rate could have been reduced in accordance to the actual space demand but its turndown should have been limited to 474 CFM if the space humidity level (50% RH) was to remain under control.

Titus chilled beam selection software features a Rapid Select function that automates this tedious selection process! It also allows designers to

determine and compare the lowest cost and most energy efficient design scenarios in minutes!

THERMAL COMFORT CONSIDERATIONS REGARDING CHILLED BEAM PLACEMENT

Active beams discharge a mixture of primary and re-circulated room air into the space. Coils provided with 57 to 59°F chilled water As a result, the room air motion created by active beams exceeds that of an all-air system delivering a similar amount of equally conditioned air by a minimum of 15 to 20%. As such, careful attention should be given to locating and sizing active beams in order to maintain occupant thermal comfort conditions that are in accordance with ASHRAE Standard 55-2017 *Thermal Environmental Conditions for Human Occupancy*.

Although chilled ceilings/sails and passive beams create minimal disturbance of room air there are still certain thermal comfort guidelines that should be observed. The following sections provide guidelines for the placement of these terminals.

Chilled panels / sails and passive beam placement

1. *Passive beams should not be installed directly above stationary occupants since the highest velocities occurring from the convection process will occur directly underneath the beam.*
2. *As previously mentioned, it is critical to the operation of passive beams that adequate space is provided to assure proper air flow through the beams. When installed in a flush mount application shadow gaps, perforated ceiling tiles, dummy beams, or return air grilles must be installed so that warm room air can freely enter passive beams. See *Passive beam application and location considerations in Chapter 2 for further details.**
3. *As both chilled ceilings/sails and passive beams require decoupled air systems for space ventilation and humidity control, outlet selection and placement should consider occupant thermal comfort as would any other all-air system.*

Active beam placement for occupant thermal comfort

There are numerous factors that can affect the selection and location of active beams. They are indeed room air distribution devices so most of the procedures and considerations that apply to overhead air distribution design also apply to active chilled beams.

Active beams can be installed parallel or perpendicular to the building façade. When they are to be used to deliver both heating and cooling to perimeter areas, they should be aligned parallel to and between 3 and 5 feet from the outside wall. This separation distance will help assure that there is no short circuiting of supply air back into the return face of the beam.

If the beams are serving a large open space where a separate heating system is used, locating the beams perpendicular to the outside wall might be preferable. This is often done in applications like heat driven laboratories where it is often beneficial to locate the beams directly above the benches and their most intensive sensible heat sources. This is rarely

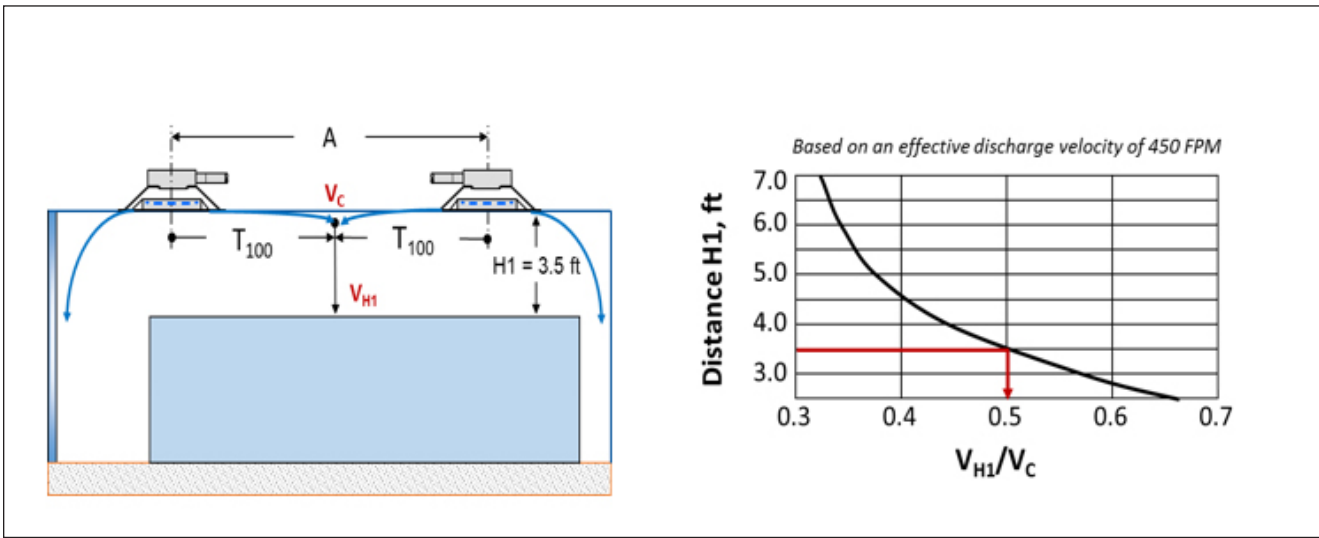

Figure 31: Velocity estimation below colliding airstreams

done, however, in individual offices due to the preferred placement of lighting fixtures in the center of the room.

Like most air distribution outlets active beams work best when mounted within ten to twelve feet of the floor, however they can be mounted higher when not tasked with heating the space.

Chapter 7 of this section discusses heating with active beams in greater detail.

After the active beam throw pattern has been decided, actual placement of the beams within the space can be determined. Placement and orientation of active beams is critical for thermal comfort due to the long throw values associated with them. Active chilled beams, because of their design, share throw characteristics with conventional slot diffusers.

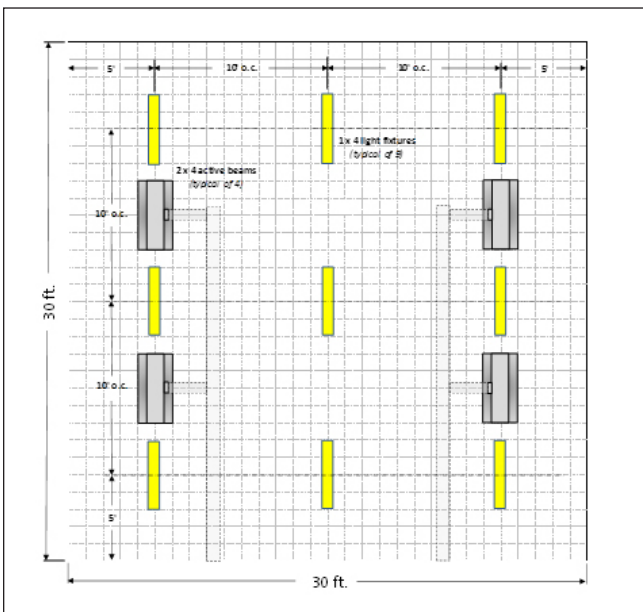

Figure 30: Typical open office beam layout

When applying single ceiling mounted beams in small interior spaces, the recommended location is as close to the center of the room as possible. This will allow the supply airstream maximum travel before it enters the occupied level of the space.

In interior open office plans it is usually cost effective to install linear type beams parallel to the space lighting fixtures. Figure 30 illustrates such a layout for a 30 x 30 interior office module. The four (4) active beams shown here would be capable of providing up to 20 Btu/h-ft² of space sensible cooling. Increasing the number of beams would accommodate higher space sensible cooling loads.

In order to provide high levels of comfort, the coverage area of a single active beam should not exceed 300 ft² of floor space.

When multiple beams are required to condition a space, care must be taken to assure that excessive velocities and draft temperatures do not occur at the point the supply air stream enters the occupied zone. This is particularly important below the collision point between two supply outlets with opposing discharge patterns.

The ideal location for most active beams is directly above the occupant. This is because the lowest velocities in the space will occur in the induced air path. As active chilled beams have air diffusion characteristics similar to that of linear slot diffusers, the same principles for determining thermal comfort conditions should be used.

Figure 31 illustrates a space where multiple diffusers are installed with opposing blow patterns. Care should be taken to ensure that velocities entering the occupied zone do not exceed around 50 FPM. Velocities along the outside walls are out of the occupied zone and do not present a threat to occupant thermal comfort. Only where opposing air streams collide above the occupied zone will excessive velocities be a threat.

When opposing air streams collide, a significant part of their individual momentum is dissipated. The graphic in Figure 31 provides guidance to

the magnitude of dissipation that might be expected when two air streams collide above the occupied zone. The further the vertical distance from the point of collision, the lower the resultant velocity (V_{H1}) of the merged airstream is as it enters the occupied zone. The example shown in the figure based on an H1 dimension of 3.5 feet predicts the velocity (V_{H1}) entering the occupied zone to be half the collision velocity (V_C) of the two opposing air streams. This indicates that spacing the two beams such that their collision velocity does not exceed 100 FPM will result in occupied zone velocities that do not exceed 50 FPM. Had the dimension H1 been greater than 3.5 feet, the collision velocity (V_C) could have been higher while maintaining the 50 FPM entry velocity (V_{H1}).

Titus active chilled beam selection software allows the user to enter the location of the active beams respect to the room surfaces, define the occupied zone height and the program will calculate the local velocities and temperatures at which the air stream enters the occupied zone.

Chapter 7

Air and water system component design

The energy savings opportunities related to chilled beam systems cannot be realized without proper selection and operation of the air and water delivery systems that serve them.

AIRSIDE DESIGN CONSIDERATIONS

Air handling unit selection and configuration

Identifying and sizing the proper air handling unit is paramount to achieving the energy savings available with chilled beam systems. The air handling unit is the buffer between the outdoor and indoor environment. It serves to condition and dehumidify the air that is to be supplied to the space. When recirculation of return air is employed, the proper mixture of outside and reconditioned air is also provided within the air handling unit.

There are a number of considerations that determine the beam system air handling unit configuration. These include:

- 1) *Is the cooling and dehumidifying process is to use chilled water or refrigerant?*
- 2) *What are the primary air conditions (temperature and absolute humidity levels) required to satisfy the space sensible and latent loads?*
- 3) *What are the heating requirements and what source (hot water or electric) is to be employed?*
- 4) *Will the air handling unit be configured for mixing or will it deliver 100% outside air?*
- 5) *What degree of energy recovery is desired (and/or required by code)?*
- 6) *Where will the air handling unit(s) be located (indoors or outdoors)?*

BASIC AIR HANDLING UNIT TYPES

Conventional air handling units may use either chilled water or direct expansion (DX) refrigerant coils. Those with chilled water coils rely on water supplied at 40 to 45°F to enable them to cool air to a leaving temperature of 50 to 60°F. This not only creates a supply to room air temperature differential sufficient to remove sensible heat from the space but also results in supply air dew point temperatures that do not exceed their leaving dry bulb temperatures. In cases where the coil's entering air dew point temperature exceeds the desired leaving dew point this is necessary to control the humidity levels within the space.

Air handling units used in beam systems may be configured to deliver a mixture of outside and reconditioned air to the space or they can be configured to condition and deliver 100% outside air to the space. Applications which employ mixing within the air handling unit are usually intended to provide a variable volume supply airflow rate to the space. These air handling units are typically paired with beam systems when a high degree of demand control ventilation (DCV) is employed or where zone sensible cooling requirements exceed that which can be accomplished at design latent or ventilation airflow rates much of the time. A mixing type air handling unit is illustrated in [Figure 32](#).

Air systems that deliver 100% outside air are referred to as dedicated outdoor air (DOAS) systems and are employed with beam systems in the following applications. DOAS units may have either chilled water or DX cooling/dehumidification coils. A unit that utilizes DX cooling/dehumidifying coils is shown in [Figure 33](#).

- 1) *Laboratory applications (where chemicals and gases are present) require 100% outside air delivery and do not allow recirculation of return/exhaust air.*
- 2) *Passive beam and chilled panel and sails applications.*
- 3) *DOAS systems are also preferred for active beam systems used in healthcare applications.*

DOAS systems are also commonly used in other applications where the primary airflow rate required for latent cooling and/or ventilation when complimented by the sensible cooling of the beam's coil is sufficient to provide the design space sensible cooling.

Note that there is no provision for mixing recirculated air with the outside air stream. The hot gas bypass allows the outside air to be heated during winter operation but also allows the primary air leaving the cooling/dehumidifying coil to be reheated when the system is operating at off-peak conditions. This can reduce zone reheat requirements as the sensible cooling capacity of the primary air can be lowered during that time while the latent cooling capacity remains constant.

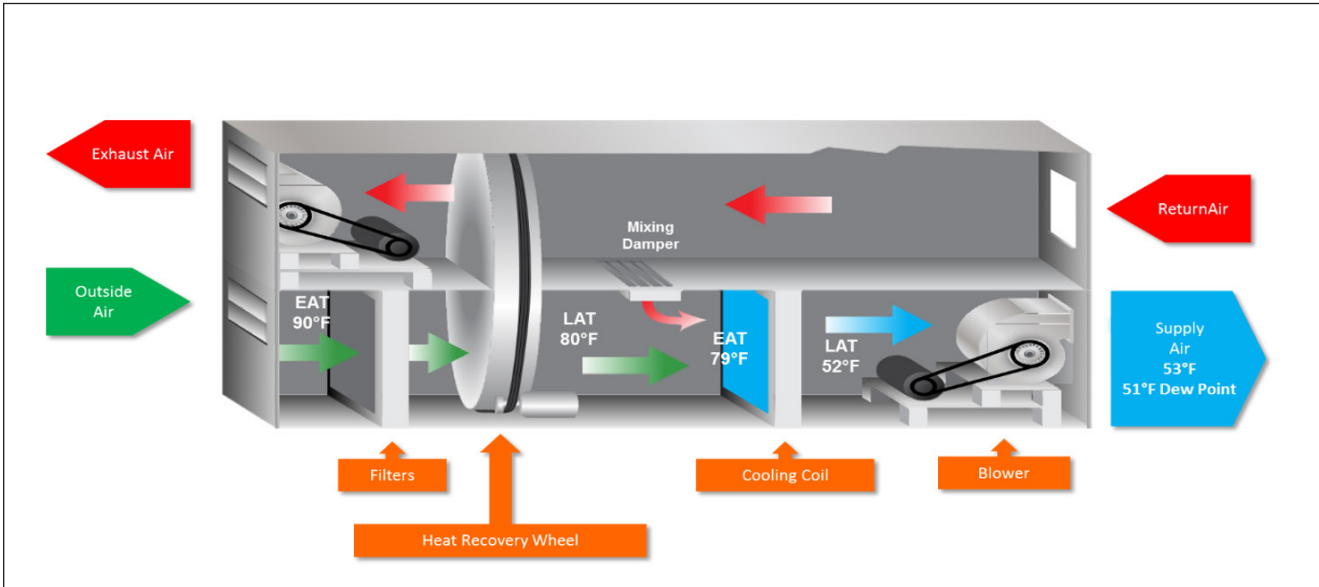

Figure 32: Mixing type air handling unit

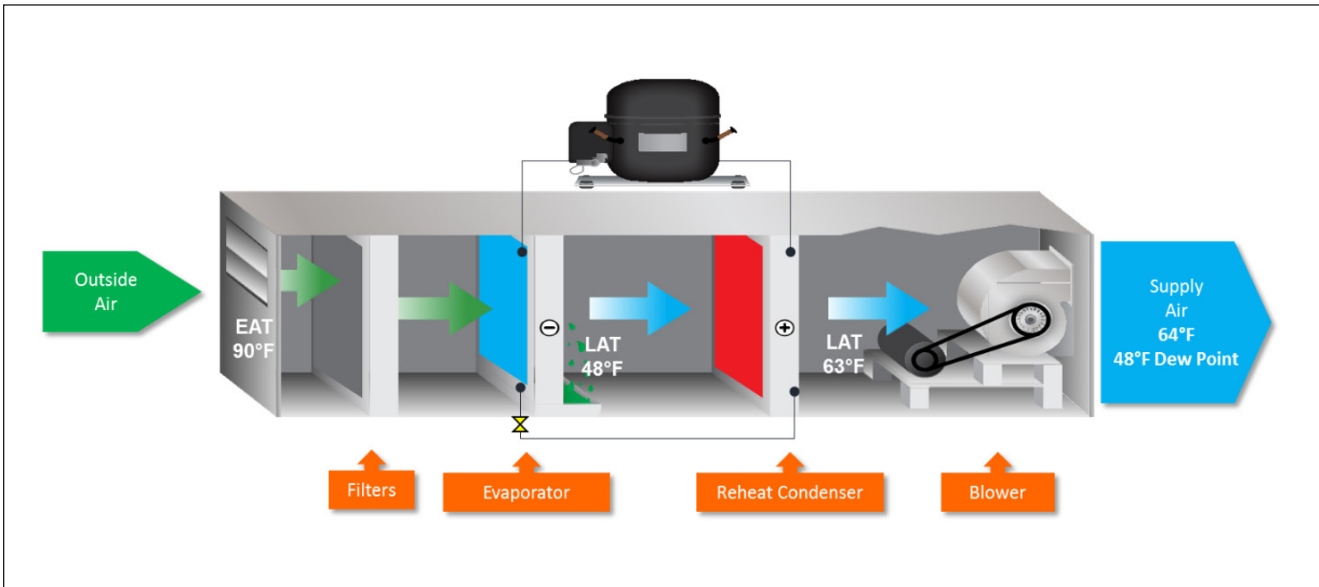

Figure 33: DOAS air handling unit with DX coil and hot gas reheat

Heat recovery options

Many energy codes require that air handling units above a certain size incorporate heat recovery.

Minimizing beam system airflow requirements to that which provides space humidity control may require that either a slightly higher room design humidity ratio be used or that the primary air humidity ratio be lowered. The effect of raising the design room humidity level was addressed in Chapter 8 and resulted in a considerable reduction in the latent cooling airflow requirement. Other applications, such as K-12 classrooms which have relatively low sensible heat gain ratios may be efficiently served by

air handling units that feature some type of secondary dehumidification provision. Figure 34 illustrates a DOAS unit with a total energy wheel and a liquid desiccant wheel. The liquid desiccant wheel exchanges sensible heat from the return air path while removing additional moisture from the primary air leaving the unit. The rotational speed of the desiccant wheel is varied by season to obtain the desired leaving air dew point temperature. Use of such a device can reduce the dew point temperature of the supply air by as much as 7°F but raises its dry bulb temperature accordingly while doing so.

Example 4 that follows illustrates the application of a liquid desiccant wheel to classroom application.

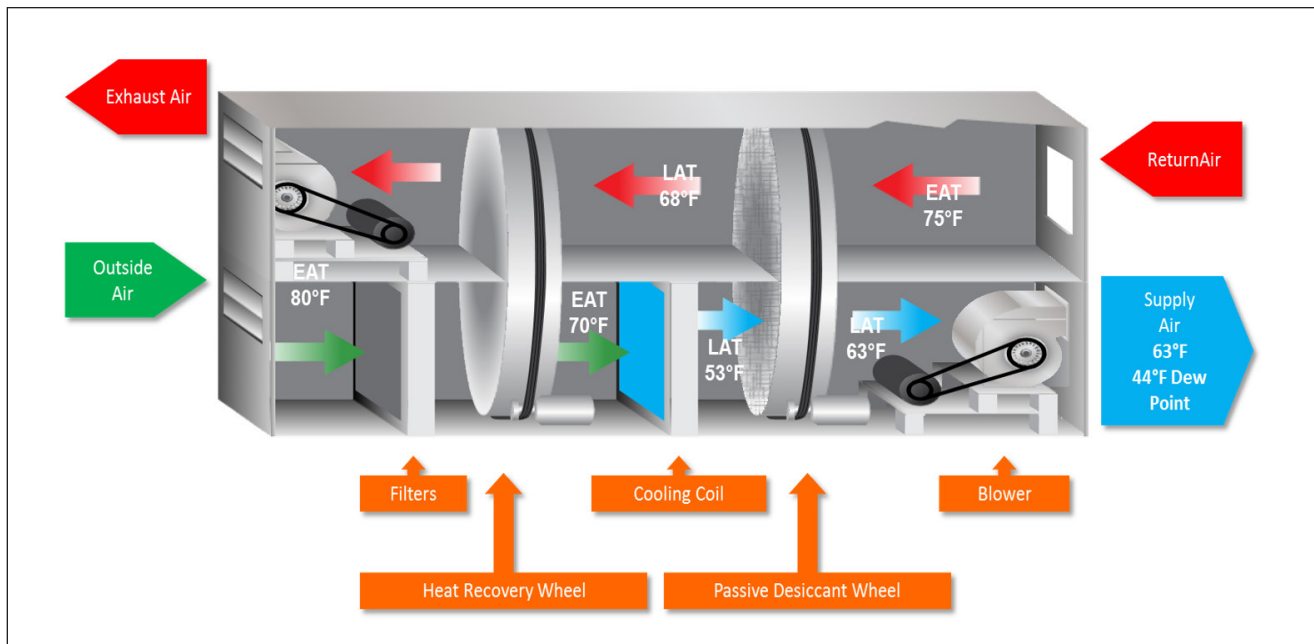

Figure 34: DOAS air handling unit with passive desiccant dehumidification

Example 4:

A K-12 classroom is to be served by an active chilled beam system. The 900 ft² classroom is designed for as many as thirty (30) occupants and has designed sensible and cooling loads of 24 and 8 Btu/h-ft² respectively. The classroom is to be maintained at 75°F and 55% RH (W = 72 grains) during cooling operation. Assuming the beams to be used are capable of providing 44 Btu/h of sensible cooling for every CFM of primary air delivered to them, determine the primary airflow rate required by a conventional DOAS (constant volume) air handling unit delivering 55°F primary air at a dew point temperature of 51°F (W = 56 grains) to a similar air handler with a desiccant wheel capable of providing primary air at 60°F and a 46°F dew point (W = 46 grains).

Solution:

First of all the ventilation (outside air) requirement is calculated as follows:

$$CFM_{VENT} = R_p \times \# \text{ Occupants} + R_A \times \text{Area} = (30 \times 10) + (0.12 \times 900) = 408 \text{ CFM}$$

The latent cooling airflow requirement of the DOAS without desiccant provisions is:

$$CFM_{LAT} = q_{LAT} / [0.69 \times (W_{ROOM} - W_{PA})] = 7,200 / (.69 \times 16) = 652 \text{ CFM}$$

The latent cooling airflow requirement of the DOAS with desiccant provisions is:

$$CFM_{LAT} = q_{LAT} / [0.69 \times (W_{ROOM} - W_{PA})] = 7,200 / (.69 \times 26) = 401 \text{ CFM}$$

As the ventilation requirement (408 FM) is now slightly greater than that required for latent cooling (401 CFM), it will be used to calculate the beam capacity. The sensible cooling contribution (Btu/h-CFM) of primary air is calculated as:

$$\text{Btu/h-CFM}_{PA} = 1.1 \times (75 - 60) = 16.5$$

Adding the primary air contribution to the water side cooling by the coil (44 Btu/h-CFM_{PA}), the total sensible cooling capacity of the beam system is 60.5 Btu/h-CFM_{PA} or 24,684 Btu/h, slightly greater than the design classroom's sensible cooling requirement.

It should be noted that in this case the classroom primary airflow requirement is reduced by 38% by using the passive desiccant wheel.

AIR DISTRIBUTION SYSTEM DESIGN CONSIDERATIONS

Duct velocity and pressure considerations

Duct velocities and pressure levels in beam systems should be maintained similar to those used in all air systems. In general, main air duct velocities should be maintained below 2,500 fpm while branch duct velocities should be between 1,250 and 1,500 fpm. Active beam inlet sizes should be selected to limit their primary air inlet velocities to no more than about 700 fpm. ASHRAE's 2017 Handbook, Fundamentals (Chapter 21) recommends duct velocities for various acoustical and physical scenarios.

Additional air system design considerations may be found in Chapters 8 and 9 of this document.

Acoustical considerations

Passive beams, chilled panels and sails create and transmit no air noise but the complimentary air systems that provide air to ventilate and control the humidity levels in the space do and should be designed to similar standards as those serving all air systems.

Active beams generate very little noise when operated at inlet pressures below 0.6 inches H₂O and velocities less than 700 fpm. Their generated noise acoustical spectra includes very little contribution in the lower octave band frequencies (125 to 1000 Hz) and the predominant octave bands that determine their sound pressure NC level are those associated with the 2000 and 4000 Hz frequencies. The small diameter of the nozzles within the beams actually attenuates low frequency duct borne noise from other system components like fans and dampers.

WATER SYSTEM DESIGN CONSIDERATIONS

Beam chilled water supply

In order to prevent condensation within the space, chilled beam and ceiling systems utilize considerably warmer chilled water (typically delivered at 57 to 60°F) than that which is used for dehumidification purposes at the air handling unit.

The best energy solution for deriving the tempered chilled water for the beam system is to dedicate a chiller to produce it. The use of a dedicated chiller offers significantly higher chiller efficiencies when generating chilled water at the temperature required by the chilled beam system. This would for instance be employed when a DX air handling unit (that does not require chilled water) is employed. There are, however, some cases where it may not be economically feasible to provide a separate chilled water system to produce the tempered chilled water.

In cases where a single chiller must be shared between the air handling unit and the chilled beam system, there are two prevalent means of deriving the tempered chilled water required by the beams.

Figure 35 illustrates the use of a plate type heat exchanger which separates the air handling and chilled beam water supply loops. Chilled water at 40 to 45°F is piped in parallel to the coiling/dehumidifying coil within the air handling unit and to the primary side of the plate heat exchanger. The closed chilled beam loop passes through the other side of the heat exchanger. The chilled water supply temperature is measured and maintained by modulating a three way valve that determines the amount of return water that passes through the plate heat exchanger.

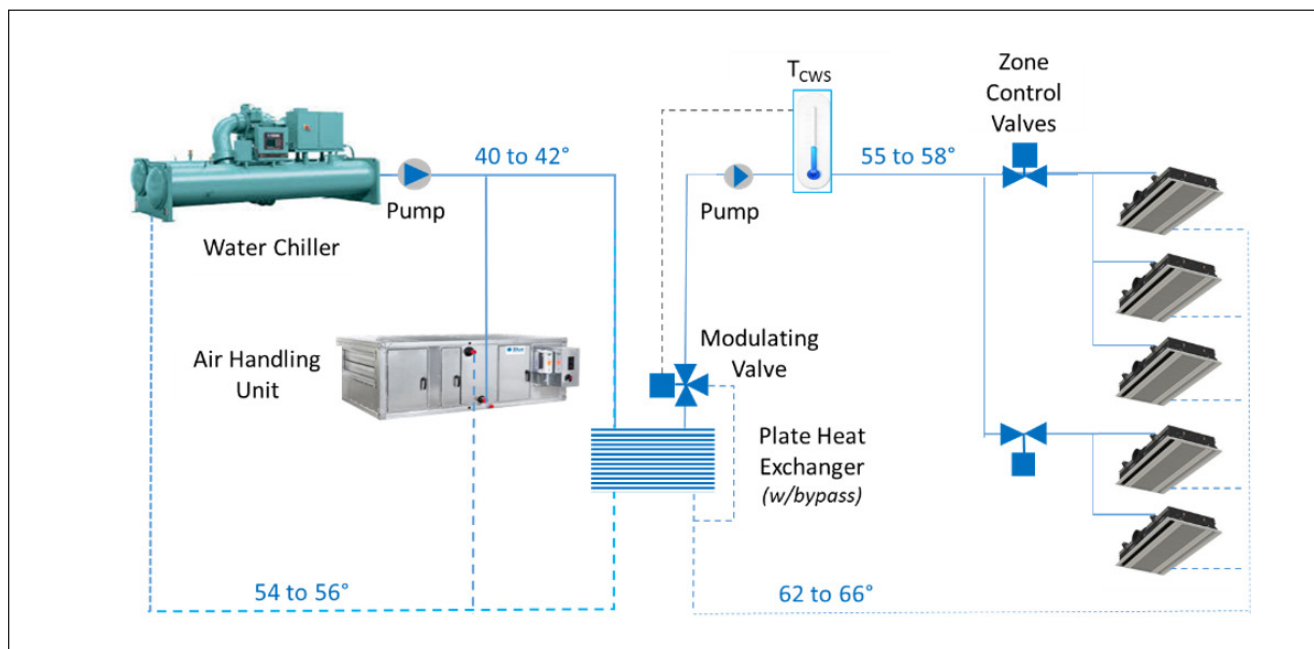

Figure 35: Shared chiller operation with closed beam supply loop

Figure 36 illustrates a strategy whereby the chilled beam loop's chilled water temperature is maintained by adding an amount of low temperature chilled water from the primary loop to make up for the heat removed as the chilled water circulates through the beam loop.

A three way mixing valve is modulated to pass primary chilled water into the beam supply loop in order to reduce its return water to the desired

beam loop supply temperature. Another mixing valve diverts a similar amount of the beam loop return water to the primary water return loop. Notice that a shut-off valve downstream of the beam loop chilled water temperature sensor is also shown. This valve is intended as an emergency back-up in case the valve modulating the chilled beam loop temperature fails and will shut-off the chilled beam loop chilled water supply in the event its supply temperature reaches a preset minimum. This will prevent

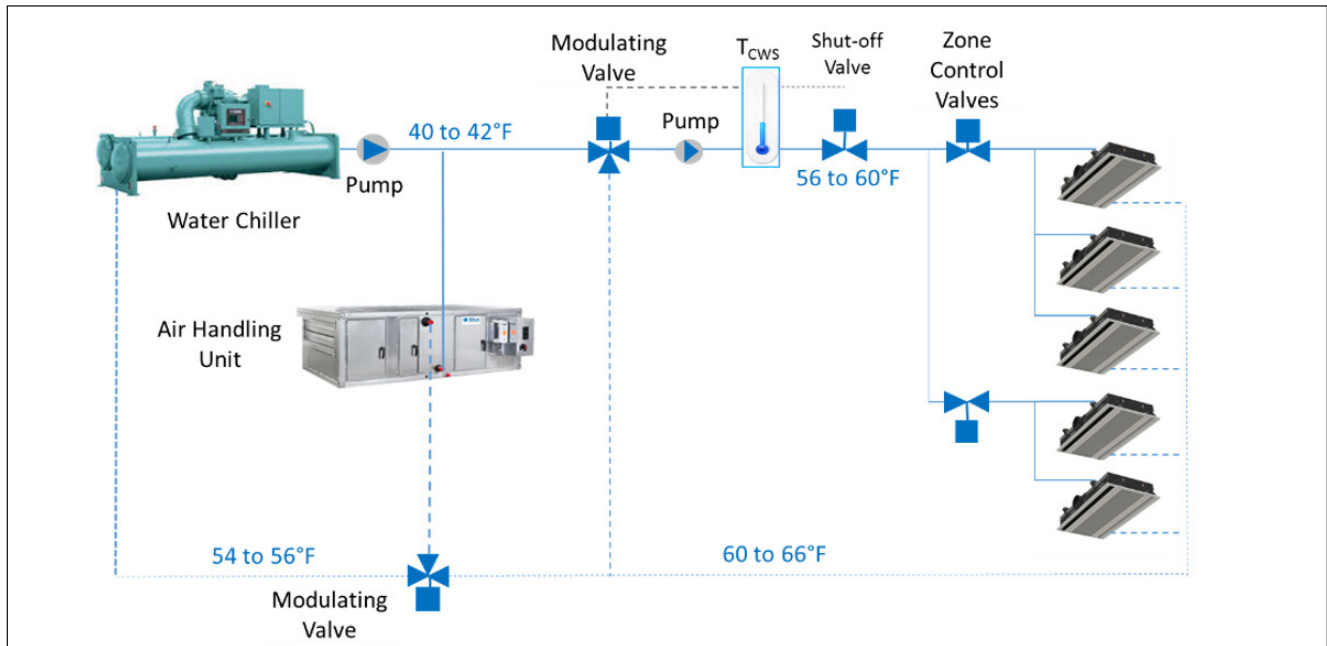

Figure 36: Shared chiller operation with open beam supply loop

beam loop chilled water temperatures from reaching levels that might result in condensation.

The use of the closed loop system shown in Figure 35 often has certain advantages over the open loop approach, among these are,

- There is no possibility of primary chilled water being passed into the chilled beam loop.
- This approach prevents operating personnel from reducing the beam chilled water supply temperatures to levels that might lead to condensation within the space.

In applications where glycol is required in the primary loop, it may not be required for the chilled beam loop.

In the case of the open loop system, glycol from the primary loop will pass into the chilled beam loop. This will not only reduce the heat transfer capacity of the beams but can also complicate water treatment within that loop.

WATER DISTRIBUTION PIPING FOR BEAM SYSTEMS

Interior zones served by chilled beam systems do not usually require heating, thus a two pipe (chilled water only) distribution strategy as shown in Figure 37 is commonly used in these areas.

Multiple beams within the same control zone are fed from a single zone chilled water control valve that is modulated by the space thermostat. Two-pipe distribution systems may also supply the beams in perimeter zones that may not require heating or where heating is being accomplished by

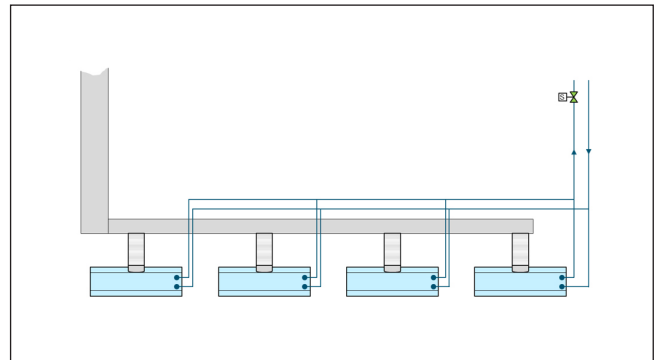

Figure 37: Two pipe chilled water distribution system

a separate decoupled heating source (see the following section regarding heating options).

Passive beams are also supplied by two-pipe distribution systems although those used in perimeter areas are accompanied by a separate heating system which often requires its own hot water distribution system.

Four-pipe distribution systems (see Figure 38) are used when both chilled and hot water must be supplied. This is usually the case applications where perimeter zones may require simultaneous cooling and heating. Active beams with four-pipe coils integrate separate chilled and hot water circuits within their shared fin stack. Most of the coil's tube passes are typically devoted to the chilled water circuit due to the significantly lesser temperature differential between the coil's mean water temperature and the air passing through it that exists during cooling mode. Separate zone chilled and hot water control valves modulate the flow of water through either one of the coil circuits according to the space demand.

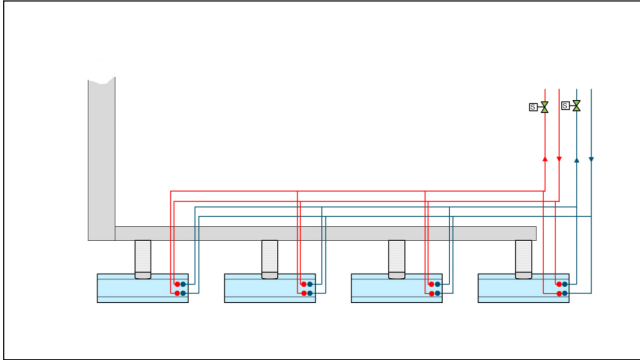

Figure 38: Four pipe active beam water distribution system

Heating with beam systems

Passive chilled beams are not effective for heating as heated air would simply accumulate in the upper levels of the space and result in uncomfortable temperature gradients within the remainder of the space. Heating in passive beam systems must thus be decoupled from the beams themselves. It is common practice to supply a separate heating system where passive beams are applied. This could be in the form of low level heating elements, radiant heating panels or within the air source providing ventilation air to the space. In these cases the temperature and flow rates of the hot water will be determined by the heating system employed.

Beam hot water supply temperature requirements depend on the heating strategy that has been adopted. The size and efficiency of the beams' heat transfer coils also enables the use of lower hot water supply temperatures (100 to 120°F) when the beams are configured for both heating and cooling. This enables their use with high efficiency condensing boilers.

There are numerous ways to integrate heating into active beam systems. One option that will not be further discussed would be to supply a two pipe changeover system (as shown in Figure 37) to the perimeter beams, but this does not allow for simultaneous cooling and heating in the various zones served by the chilled beam system.

Four-pipe distribution systems as shown in Figure 38 are commonly used to provide heating to perimeter zones. The space thermostat modulates the hot water flow through the coil while the zone chilled water supply remains off. While this method has been proven to work well, it has certain limitations.

- The cooling circuit usually comprises 70 to 80% of the coil therefore the beam's cooling and heating capacity is less than that which would be afforded by a dedicated cooling and heating coil.
- The use of four-pipe coils requires that both heating and cooling, supply and return piping be ran and connected to every beam within the zone. This can significantly increase system installation costs.

An option that is often employed in cold climates is to decouple the perimeter heating from the beam system by using low level heating. These

may be hot water, steam or electric elements. The use of decoupled heating also allows set-back heating while the air handling unit remains off. This is often desirable in applications such as K-12 educational facilities.

Titus TAO displacement chilled beams incorporate low level heating coils which provide static heat even when the air handling unit is off.

Figure 39 illustrates a heating option that involves installing a single heating coil in the primary air duct that feeds all of the beams within the zone. This still requires a four pipe water distribution system to the zones but eliminates the heating circuit run-out piping to each individual beam, significantly reducing installed costs. This is particularly attractive for applications in mild climates.

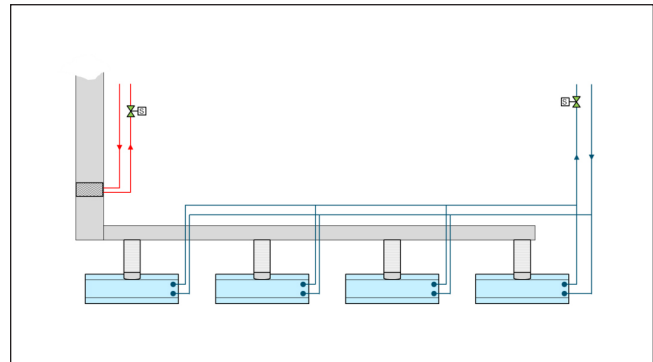
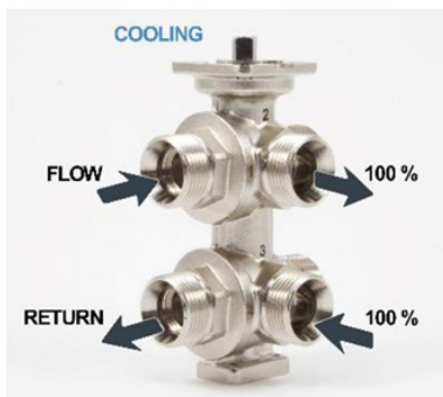

Figure 39: Heating with a zone duct mounted coil

It should be noted that heating the primary air will result in a need for higher hot water temperatures than would be possible with heating provided by the coils within the beams. Heat is being transferred to the primary airflow (far less than the induced airflow rate involved with heating within the beams), through a much smaller coil and thus has to be delivered at a much higher temperature. Two row coils with hot water supply temperatures (160 to 180°F) similar to those employed by all-air terminals are typically required for this application.

Six port zone control valves (illustrated in Figure 40) have become increasingly popular for use in active beam systems. These valves have separate supply and return ports for chilled and hot water. A zone thermostat not only dictates whether chilled or hot water is required but also modulates the chosen medium's flow rate according to the space comfort demand. The use of six port valves provides the same advantages as heating with the duct mounted coil (Figure 39) while allowing the use of lower temperature hot water similar to that employed by a four pipe beam system.



Cooling Operation

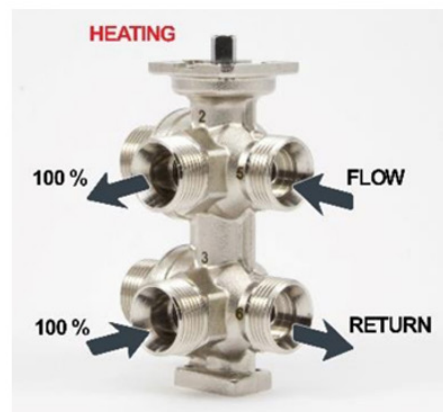

Heating Operation

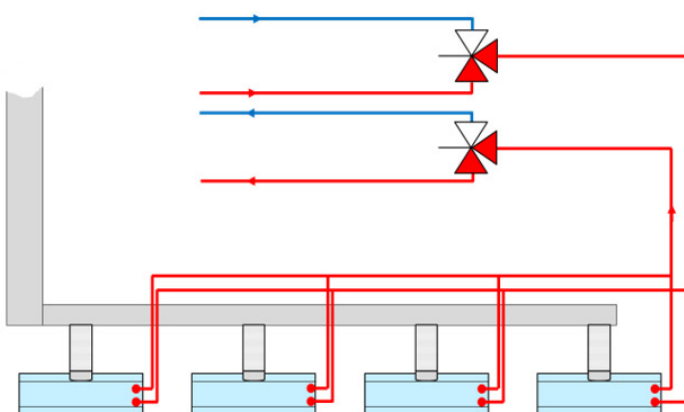
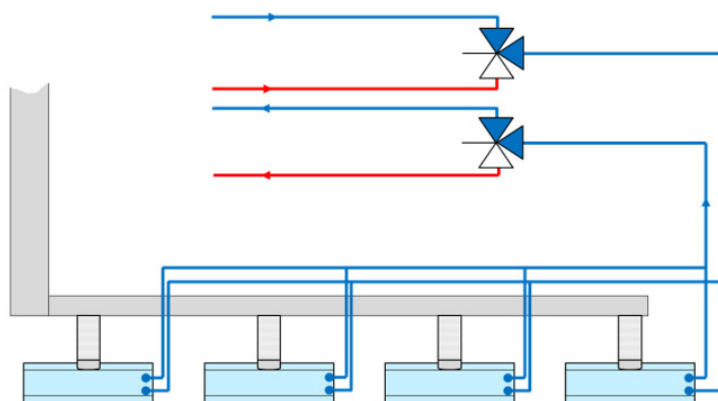

Figure 40: Active beam cooling and heating with six port valves

This method of heating has several advantages:

- While a four pipe distribution system is required to deliver chilled and hot water simultaneously to the zone, the use of six port valves results in a single supply/return piping loop to the beams themselves.
- The coils within the beams can be configured as two-pipe which means the entire coil will be utilized for both cooling and heating. This often allows the employment of lower hot water supply temperatures that accommodate the use of high efficiency boilers.
- The operation of the valves can be adjusted to provide a “dead band” around the zone thermostat setting where neither chilled nor hot-water will be delivered to the beams.

Applications. Even in the case of the duct mounted coil, the induction of room air will continue and will reduce the temperature differential between the primary and supply air resulting in the same discharge temperature created by the other strategies.

CHILLED BEAM SYSTEM PIPING CONSIDERATIONS

There are several items to be considered when designing the piping that comprises the chilled beam water distribution system. These include:

- Determination of water flow rates
- Type of control valves to be used
- Commissioning and balancing of the water distribution system

Regardless of the heating strategy chosen, active beams will have the same discharge air temperature for a given amount of heating delivery. This discharge temperature should not exceed the 15°F room to supply air temperature differential recommended in the 2015 ASHRAE Handbook,

Water flow rates for beam systems

It is important to size the piping serving the chilled beam system according to the water flow rate they must transport. Water flow rates should remain high enough to assure that turbulent flow is maintained at design conditions and limited to flow rates that do not create excessive water noise or pressure drops. Table 6 suggests minimum and maximum water flow rates for various copper pipe diameters that may be serving the beam water distribution system.

Note that the copper tubes within the beam coils themselves are typically 3/8" nominal size (1/2" outside diameter). These coils may be configured as single or dual circuit, depending on the water flow rate they require. In order to assure that they do not create water noise when their water flow rate is increased to its maximum, water flow rates should be limited to no more than 2 GPM per circuit. In order to maintain turbulent flow, the design water flow rates for the coils should also not be less than 0.3 GPM per circuit.

Nominal Copper Pipe Size	Outside Damper (in)	Inside Damper (in)	Minimum flow rate (GPM)	Maximum flow rate (GPM)
3/8"	0.500	0.450	0.30	2.0
1/2"	0.625	0.569	0.40	3.5
5/8"	0.750	0.690	0.45	5.0
3/4"	0.875	0.747	0.50	5.5
1	1.250	1.110	0.75	12.0
1 1/4"	1.375	1.207	0.80	15.0
1 1/2"	1.625	1.527	1.00	25.0
2	2.215	2.099	1.35	45.0
2 1/2"	2.625	2.499	1.60	65.0

Table 6: Recommended beam system water flow rate ranges

Another consideration in specifying beam water flow rates is the diminishing return associated with increased water flow rates. Figure 175 illustrates the performance of an active beam cooling coil at varying chilled water flow rates. Note that the coil's cooling capability drops off significantly as the chilled water flow rate is increased above about 1 GPM (tube velocity of around 2 fps). Increasing the GPM from 1.0 to 2.0 GPM may result in only a 10 to 20% increase in cooling output but is accompanied by a four-fold increase in the coil's pressure loss. The pressure loss can be mitigated by specifying a dual circuit coil which halves the water velocity through the tubes but will typically reduce the coil's cooling capacity by 5 to 10% as well.

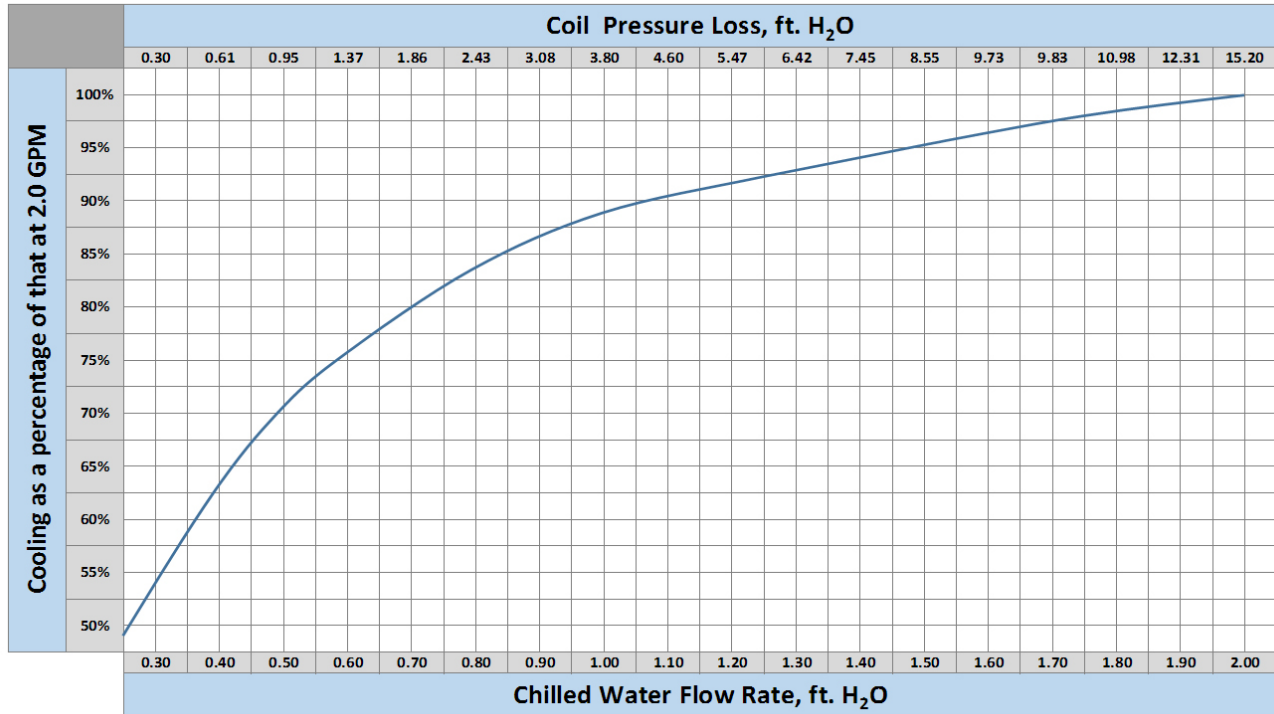

Figure 41: Relationship between water flow rates and cooling capacity

Zone piping considerations

Common beam system zone piping configurations are illustrated in Figure 42.

Direct return zone piping results in varying distances from where the beam piping circuit leaves the supply branch to where it reconnects with the return. Multiple beams within a zone serviced by direct return piping will require balancing of the individual beam flow rates within the zone and thus each beam will have to be installed with provisions for adjusting its water flow rate(s).

Reverse return piping involves equalizing the water circuit lengths of the various beams served by the zone control valve. Doing so affords little need to balance the individual beam flow rates in order to accomplish a similar flow rate through the individual beams.

Control valve and actuator selection

Zone temperature control in chilled beam systems can be accomplished with either two way (on-off) or 3 way mixing valves. Figure 43 illustrates two common methods of zone water flow control. Two way valves are commonly used with variable speed pumps to modulate the zone water flow. Space temperature sensors control the volume flow rate of water in accordance with the space sensible cooling/heating demand.

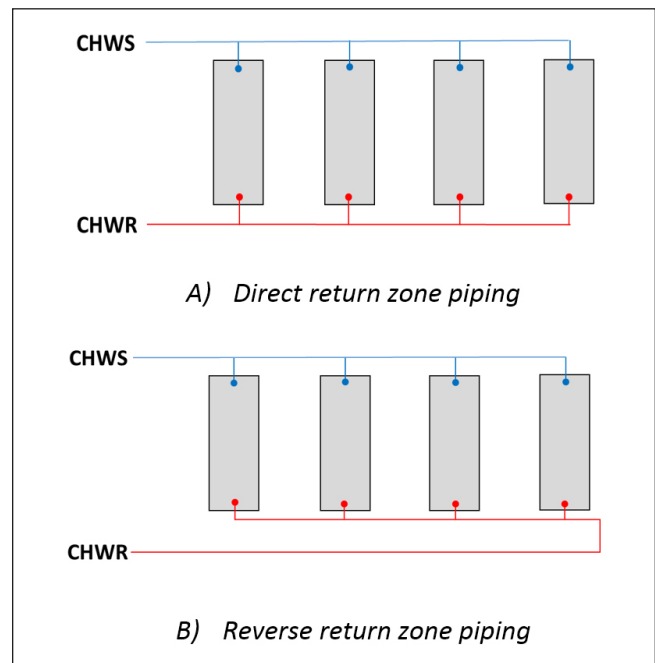

Figure 42: Zone piping configurations for chilled beam systems

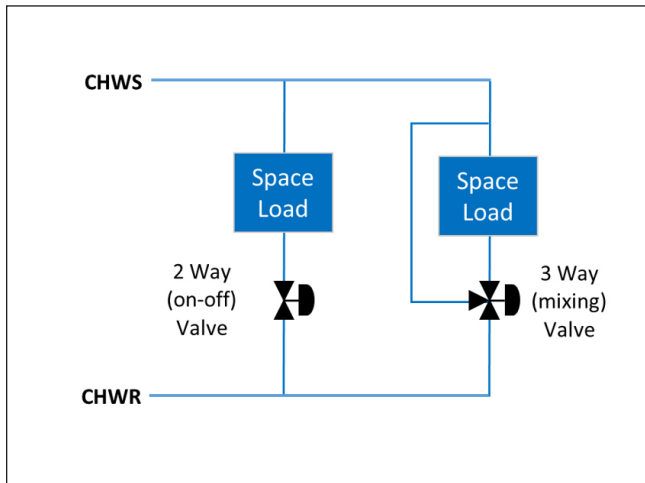

Figure 43: Zone control valve selection

Active beam systems commonly use two way valves unless very precise control of the space temperature is required. Two way valves are less expensive and their actuators tend to last longer as their duty cycle is far less than mixing valves.

Three way mixing valves are commonly used in applications where constant volume system water flow rate applications. These valves are also commonly used with passive beams and chilled panels and sails to provide more sensitivity to space temperature modulations.

Selecting zone control valves with an appropriate valve authority is also important although this can be negated by using pressure independent control valves.

Chapter 8 System control and operation

Decoupling the space sensible cooling from its ventilation and latent cooling demands often allows reduction of the ducted air volume by 50 to 80%. Many air-water systems applied in healthcare and laboratory facilities deliver 100% outside air to the space and therefore utilize Dedicated Outdoor Air Systems (DOAS). The ducted airflow rates in other applications like classrooms are often so close to the space outside air requirement that DOAS units are often employed there as well. The aAir handling units used in DOAS applications typically have a total energy recovery wheel and may employ desiccant dehumidification to remove additional moisture from the supply air. This moisture removal does not however come without an energy penalty as the wheel often adds an additional 0.75 to 1.0 inches of static pressure across the supply and exhaust fans. An alternative and preferred means of providing space humidity control is to increase the design humidity of the space. As mentioned earlier, controlling the humidity in a space designed for 75°F dry-bulb and 55% relative humidity will typically require 60 30 to 6540% less supply air than controlling the room humidity at 50%!

Critical zone control points that must be maintained are the entering chilled water temperature, space dew point temperature and the primary airflow rate. After control of these critical points has been established, controls that respond to changes in space dew point temperature and occupancy may be considered and managed through a building automation system.

TEMPERATURE CONTROL AND ZONING OF AIR-WATER SYSTEMS

Zoning for air-water systems should be similar to that applied to all-air systems. If four separate offices would have been served by a single VAV terminal, the same rooms should be served by a single chilled (and hot, if applicable) water valve and thermostat. All of the beams within that control zone would then be piped and ducted in parallel.

Room air temperature control in spaces served by air-water systems is primarily maintained through the regulation of chilled and/or hot water control valves. Two-way valves may be operated as on-off or proportionally controlled. Pulse width modulation (PWM) control may also be used. Three way mixing valves can also be used but consideration should be given to their benefit versus added cost. For more information regarding control valves, see Chapter 7.

Chilled beams should be connected in parallel so that each beam sees the same entering water temperature. Typically, one actuated control valve (two if heating is required) services each zone. Each beam should be fitted with isolation valves on the both the supply and return. Figure 44 illustrates a typical beam zone piping schematic. A single control valve controls the flow of chilled or hot water to multiple beams. Each beam piping circuit is fitted with manual shut-off valves, a strainer, and a balancing valve. Pressure/temperature (P/T) measurement ports are also supplied to allow commissioning of the water circuit servicing the device. Drains and air vents are often furnished on the coil within the beam but system air vents should also be located at the high point on the zones hydronic circuit.

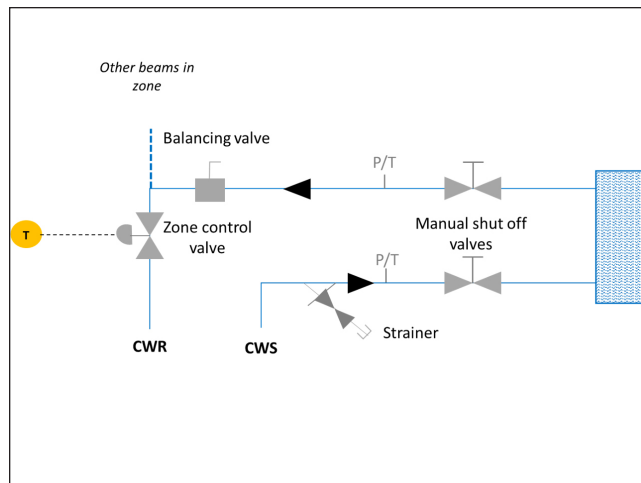

Figure 44: Individual beam piping configuration

Constant primary air volume operation of beam systems

Air-water systems are often operated with a constant volume flow rate of primary air. Chilled panels and sails completely decouple space sensible cooling from its latent cooling and ventilation. The decoupled air supply flow rate can be varied but it is solely determined by the space latent cooling and ventilation requirements which typically don't vary much.

Active beams can often be sized to provide the required space sensible cooling at a primary airflow rate that is similar to that required for the maintenance of space ventilation and humidity levels. In such cases, any potential primary airflow rate turndown is minimal if space humidity levels and ventilation rates remain the same.

Figure 45 illustrates an active beam system that provides space cooling and heating with a constant volume primary airflow rate. When the space temperature is at or near its set-point value both the cooling and heating coils remain off. The constant volume primary air supply controls the space humidity, maintains acceptable ventilation and contributes some sensible heating and/or cooling when its delivery temperature is different than the room temperature. As the space temperature rises, the chilled water flow through the beam's coil is increased to offset the temperature rise. This continues until the space temperature is brought back to its control set-point. If the temperature continues to drop, the chilled water valve remains closed while the zone hot water valve modulates the flow of hot water through the beam's coil until the space temperature setting is restored.

Constant primary air volume beam systems can also be configured for unoccupied period operation at a lower constant volume airflow rate. If operated this way, the chilled water supply to the beams should be discontinued during set-back operation and should not be restored until the space dew point temperature has been re-established below the chilled water supply temperature.

Variable primary air volume with active beam systems

While chilled beam systems often deliver a constant volume of air to the space during occupied conditions, the primary air delivery can also be regulated according to space occupancy and thermal demand. Although discontinuance of the chilled water supply to the coils affects a sensible cooling turndown of 60 to 80%, the primary airflow rate can also be reduced (see **Figure 46**) to provide further turndown and eliminate reheat. When this operation is employed care must be taken to assure that the space latent cooling and ventilation requirements are satisfied during the periods of reduced primary airflow.

Demand control ventilation using active beam systems

Chilled beam system primary airflow rates can also be regulated by CO₂ sensors to provide demand control ventilation to conference and meeting rooms. **Figure 47** illustrates a control schematic that provides demand control ventilation.

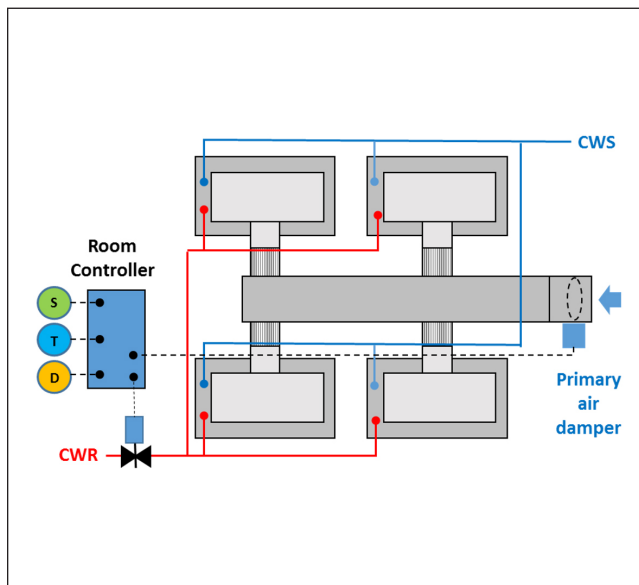

Figure 47: Demand control ventilation with active beam systems

When designing systems with occupied/unoccupied modes or with night set back it is critical to ensure the design relative humidity conditions are met prior to the initiation of the chilled water flow. In most cases, 30 minutes of dry-air ventilation will be enough to restore the room dew point temperature to a level where the chilled water flow can be safely restored.

Fan assisted DOAS terminals

Titus LSC series fan assisted terminals can be an alternative to, but are often used to compliment, active beam systems. These terminals are series type fan terminals which include a pressure independent primary air damper, sensible (dry) cooling coils and optional hot water or electric heating coils. They are also equipped with high efficiency EC motors.

Figure 48 illustrates a LCS series terminal. Their pressure independent primary air damper maintains a pre-determined volume flow rate of preconditioned air from a DOAS air handling unit. Their variable speed fan induces plenum air which passes through the unit's cooling coil where sensible heat is removed in accordance to the zone's cooling demand. This reconditioned air is then mixed with the ducted ventilation air and delivered through conventional diffusers serving the space. The (optional) hot water or electric heating coil can heat the air mixture (while the sensible cooling coil remains inactive) during times of zone heating demand.

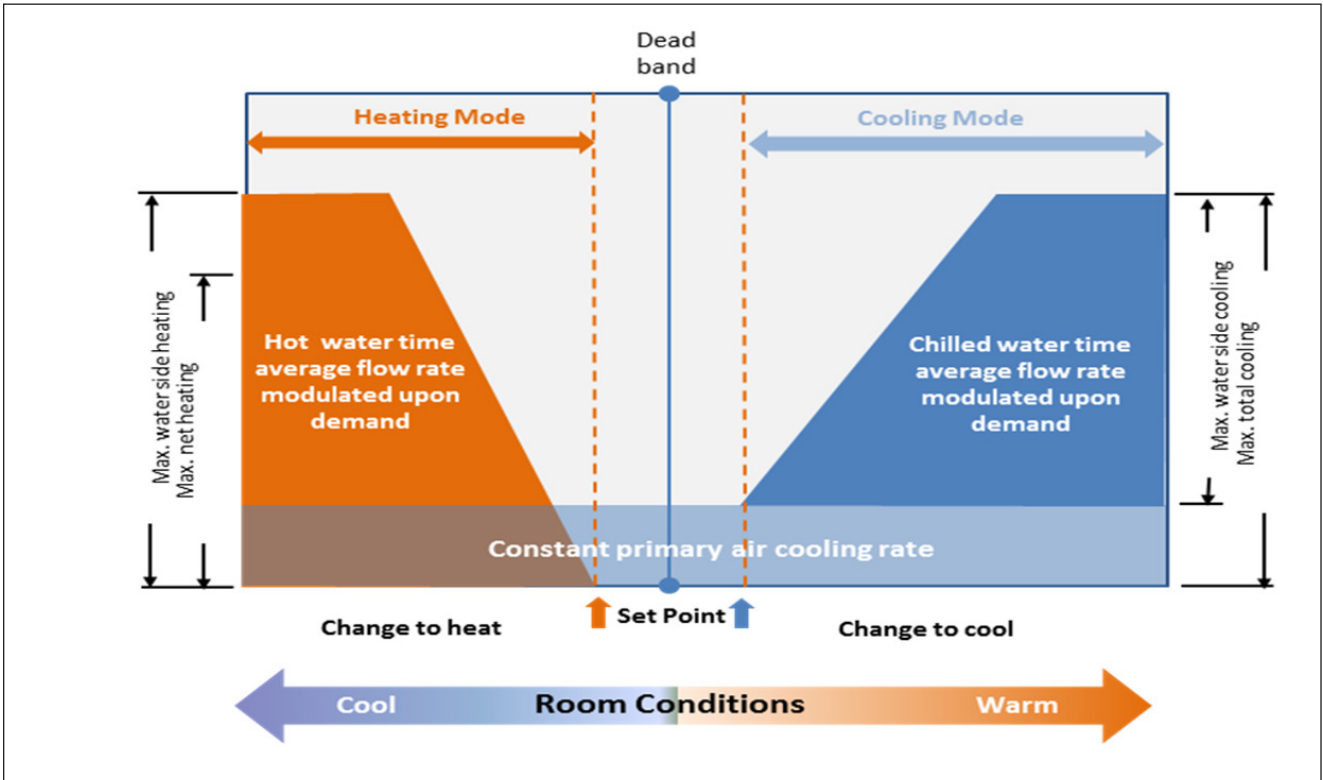

Figure 45: Constant volume primary air operation of active beams

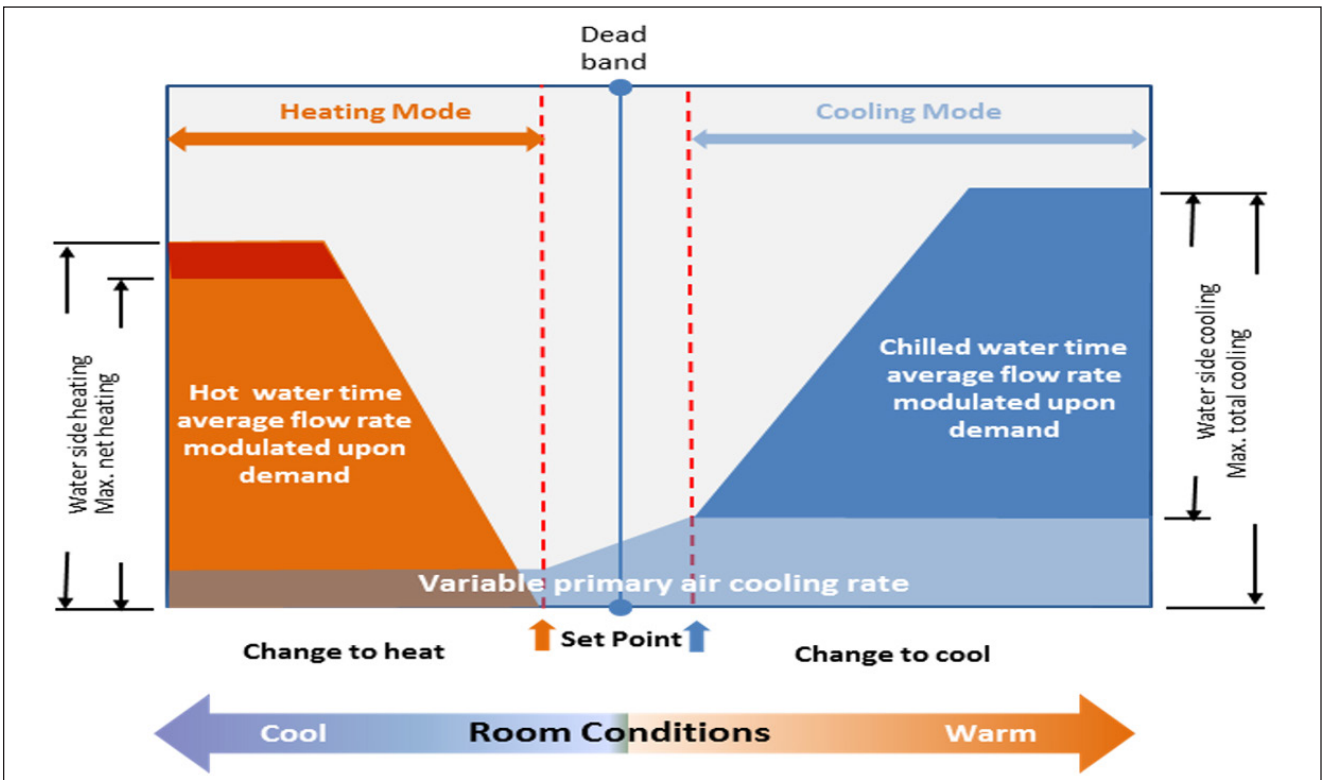

Figure 46: Variable air volume operation of active beams

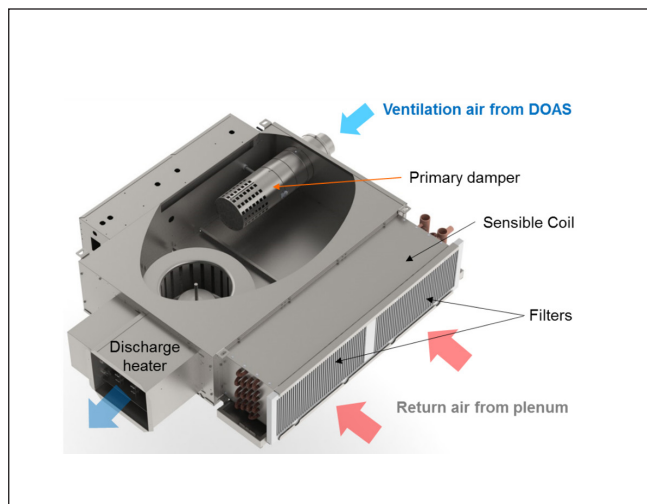

Figure 48: Sensible cooling fan terminal for DOAS operation

LSC series terminals can be used in certain areas as ideal compliments to an active beam system. These terminals are served by DOAS primary air and their sensible cooling coils employ the same chilled water temperatures as active beam systems. Some key benefits of LSC terminals are as follows:

- LSC terminals serving perimeter zones can be used for unoccupied mode heating without having to operate the building's central air handling units. *Ceiling based active beams require pressure from ducted primary air to effectively heat and would therefore require a separate decoupled heating system to accomplish this.*
- LSC terminals can often be used to condition entrance levels, lobbies and other high infiltration areas with conventional air diffusion devices. *See Chapter 9 Condensation risk, prevention and detection for more details.*

Chapter 9 Condensation risk, prevention and detection

Condensation should not be of major concern when beams are installed where indoor humidity levels can be properly monitored and maintained. Beams are serviced by chilled water delivered at or above the space dew point which in most cases means 57 to 60°F. The mean water temperature in the coil is typically 3 to 5°F warmer than the supply water temperature. Room air movement through active beams also results coil surface apparent dew point temperatures that are several degrees below that which is sensed within the space it serves. In fact, the surfaces on these air-water devices remain warmer than that of a ceiling diffuser delivering 55°F supply air to the space.

Applications that involve uncontrolled infiltration should, however, employ some type of dew point sensing and overrides that a) increases the primary airflow rate, b) resets the chilled water supply temperature and/or

discontinues the chilled water flow when condensation risks exist.

There are numerous methods of condensation prevention and control available to the system designer. These measures can be generally categorized as proactive or reactive. Several of these methods are described below.

Reactive condensation prevention measures

Reactive condensation prevention measures are those which react to the actual detection of condensation formation. Once condensation has been detected, the first action that is taken is to discontinue the chilled water supply to the zone. The duration of chilled water flow disruption depends on the type of sensor used. Space temperatures often rise considerably during this time period and result in occupant comfort complaints.

Earlier chilled beam projects often relied on surface moisture sensors (like the one pictured in [Figure 49](#)) that mounted to a bare section of the chilled water supply pipe. Upon detection of moisture they reacted by shutting off the chilled water flow to the zone. Some of the sensors also sounded an alarm upon their detection of moisture. The chilled water flow was not resumed until the sensor no longer detected moisture and reset to its normal position. These sensors have proven to be so sensitive they activate well before visual evidence of condensation occurs.

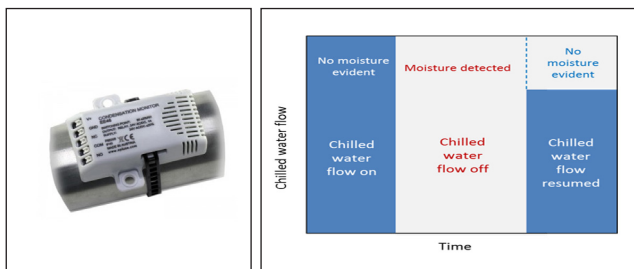

Figure 49: Condensation prevention using surface moisture sensors

Contact switches ([Figure 50](#)) can also be used to discontinue zone chilled water flow upon the opening of a window. In the event they are used, a room humidity sensor should also be incorporated to assure that the chilled water flow does not resume until the design space dew point temperature is restored.

The use of contact switches may not be economically practical where operable windows are divided into numerous sections.

A third method is (illustrated in [Figure 51](#)) of reactive prevention relies on a space dew point or relative humidity sensor instead of the surface moisture sensor. While this measure also results in immediate discontinuance of the zone chilled water supply, the period during which flow is suspended tends to be shorter due to the reaction of the room sensor.

Certain active beam models with vertical coils may be provided with condensate trays. These beams are typically employed in areas where accurate control of the space humidity levels cannot always be guaranteed. These include classrooms and other space with operable windows. In

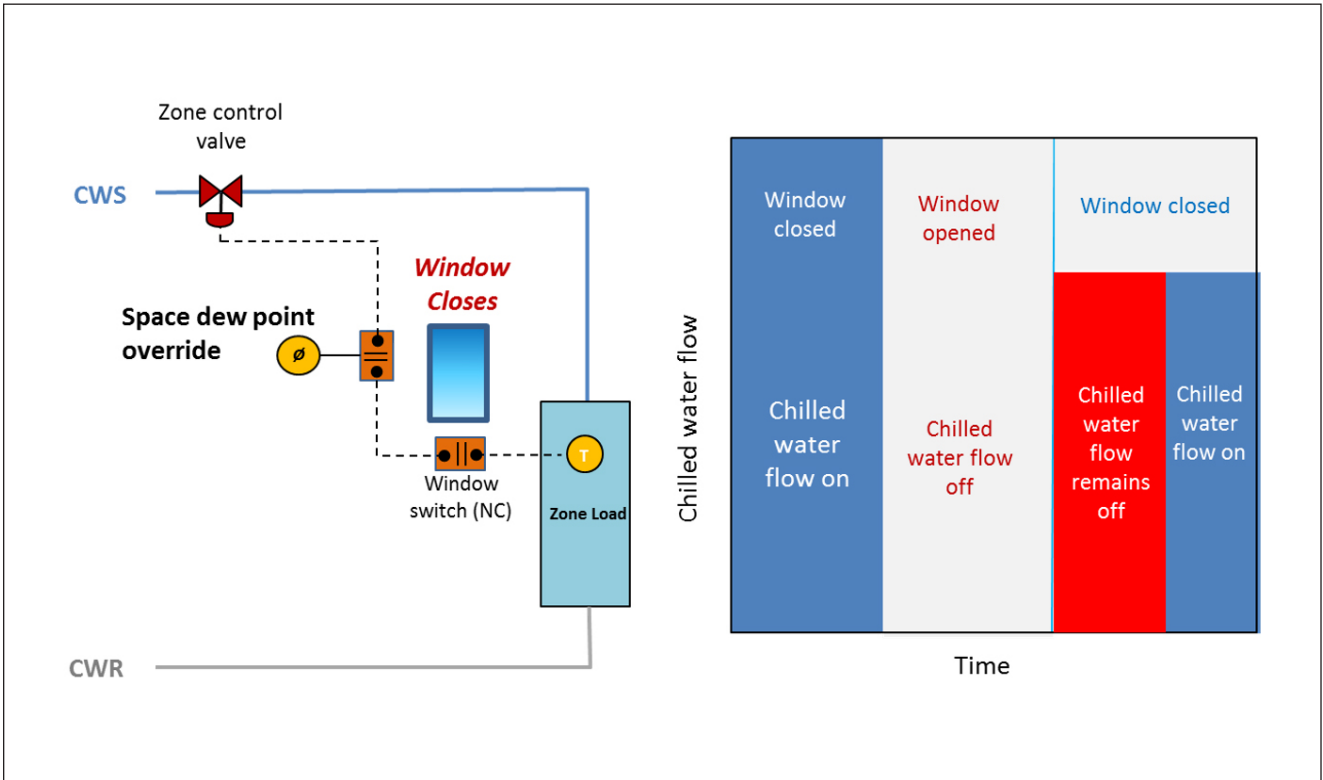

Figure 50: Reactive control using window position sensing

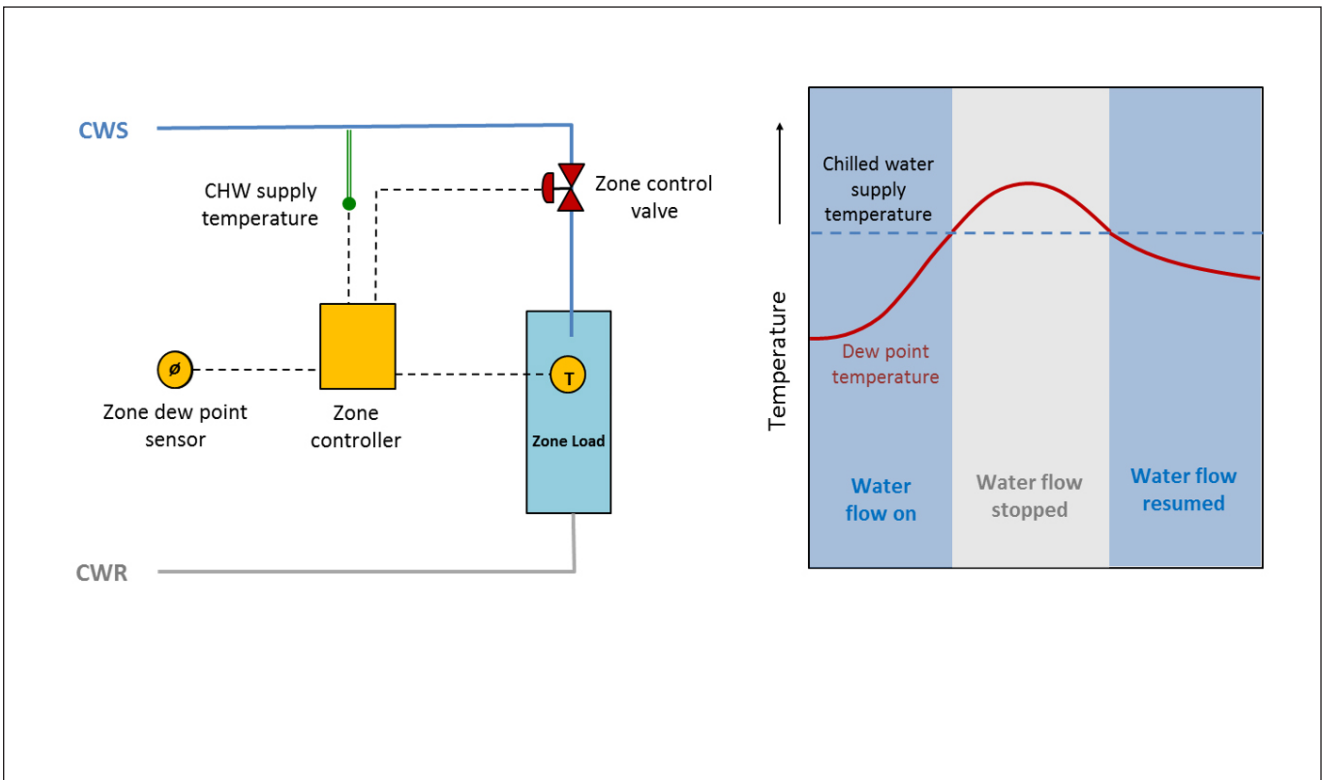

Figure 51: Reactive condensation control using zone humidity sensing

such cases a float switch (see Figure 52) can be fitted to the condensate tray and used to shut off the zone chilled water flow (and send an alarm to the building operator) when the float reaches a preset vertical position. This allows humidity level fluctuations as the infiltration rate is varied.

Proactive condensation prevention techniques

Proactive condensation prevention involves the measurement of chilled water supply temperatures and room humidity levels to prevent the formation of condensation.

Figure 53 illustrates a preventative control strategy that relies on zone dew point sensing to modulate the primary airflow rate in the event the dew point exceeds the chilled water supply temperature. This allows the chilled water flow to the zone to be continued while an increased volume of primary air is delivered to offset the increased dew point.

Condensation can also be avoided by modulating the chilled water supply temperature in response to changes in the measured dew point temperature. Figure 54 illustrates a case where the indoor dew point and chilled water supply temperature are monitored and the chilled water supply temperature is reset to maintain a constant differential between the two measured values.

This strategy is generally applied on floor by floor basis where operable windows are not employed. Dew point sensors are located at two or three locations per floor that are deemed representative and/or where condensation would most likely occur first. A dew point controller monitors the sensors as well as the chilled water supply temperature as it enters the floor. In the event the dew point temperature indicated by any one of the sensors rises to within a pre-set differential of the water supply temperature, the controller positions a mixing valve to allow an increasing

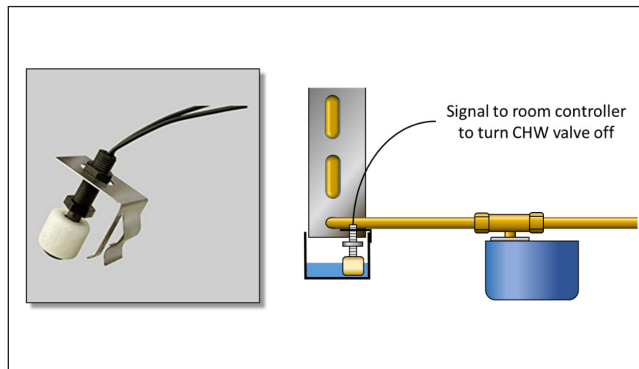

Figure 52: Reactive condensation control using float switches

amount of return water to pass into the beam supply loop and reset the dew point to supply temperature differential.

A recirculation pump and modulating valve is required for each point at which the supply water temperature is to be reset. While it is possible to apply this strategy on a zone by zone basis, it may not be economical to do so.

Secondary condensation prevention and control strategies should only be implemented where condensation is of valid concern. *Adding unnecessary controls may result in significantly higher system installation costs.*

Treatment of entrance lobbies and other high infiltration areas

LSC fan terminals (introduced in the previous chapter, see Figure 55) can be used effectively in lobbies, entrance areas and other applications where intermittently high infiltration rates may make accurate space humidity level control difficult to achieve.

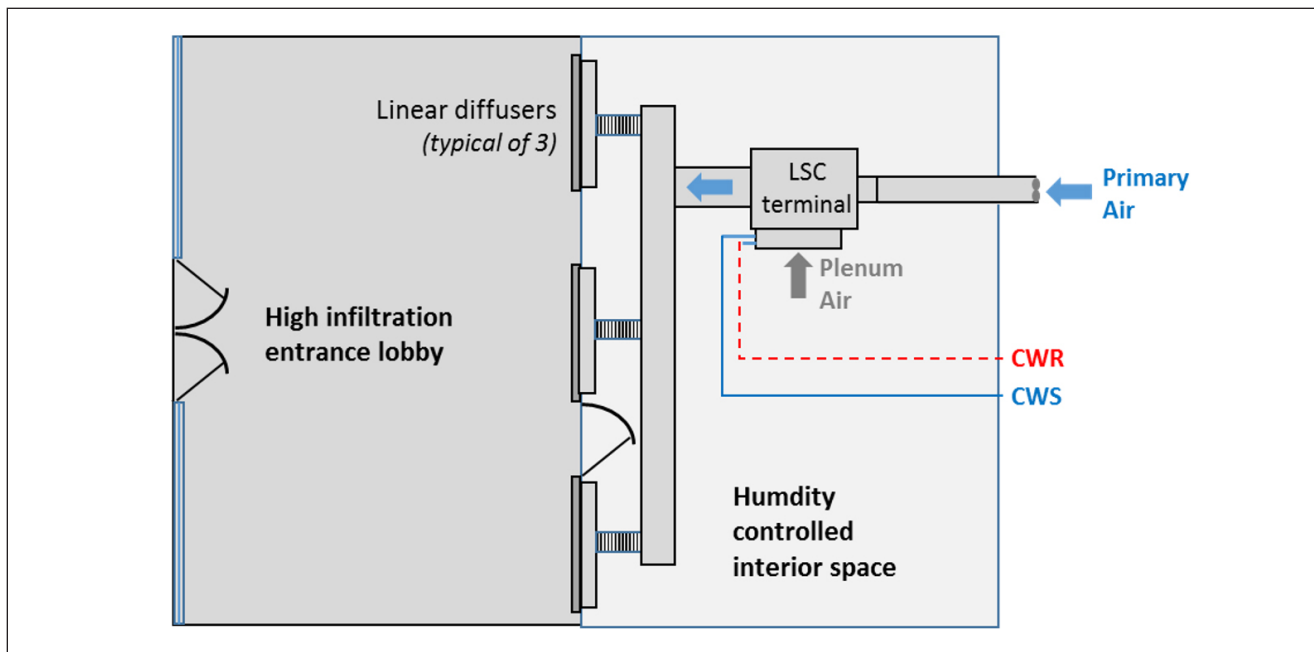

Figure 55: LSC terminal conditioning an entrance lobby

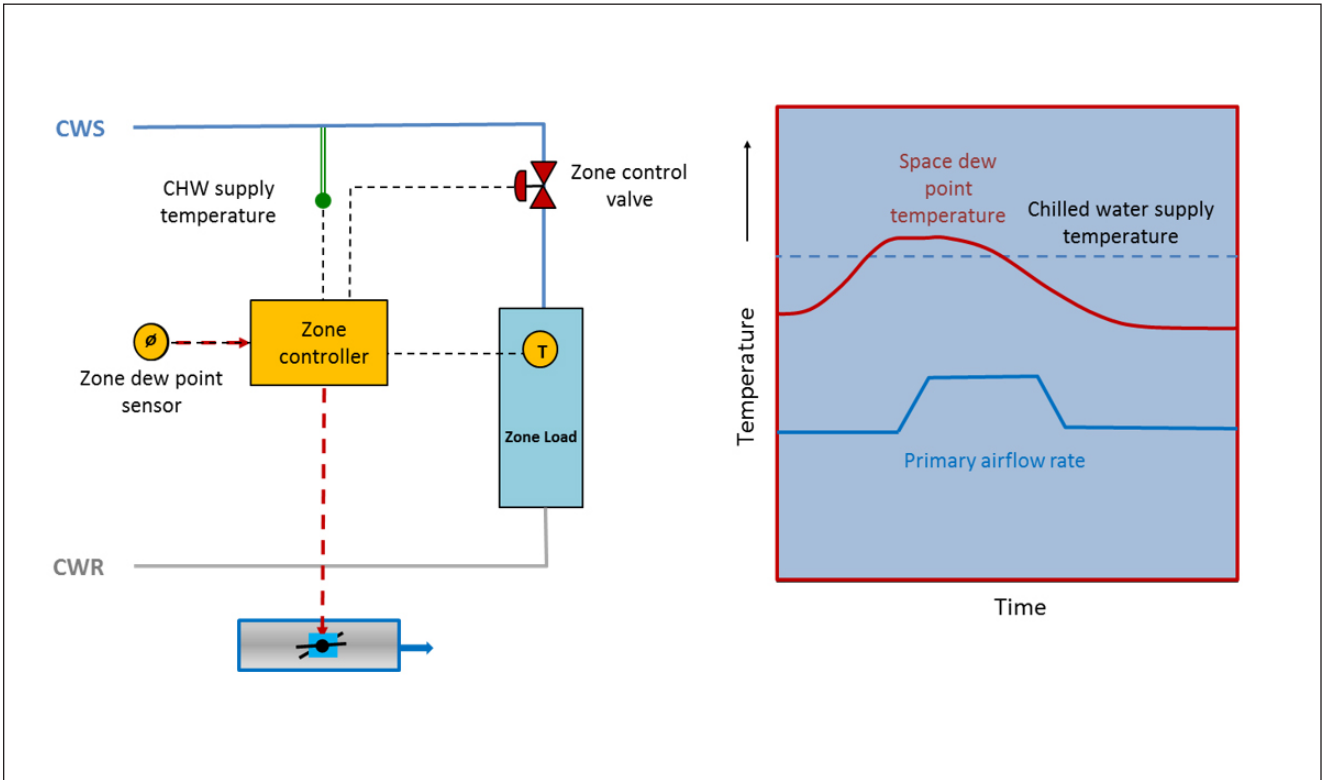

Figure 53: Increasing zone primary airflow rates to prevent condensation

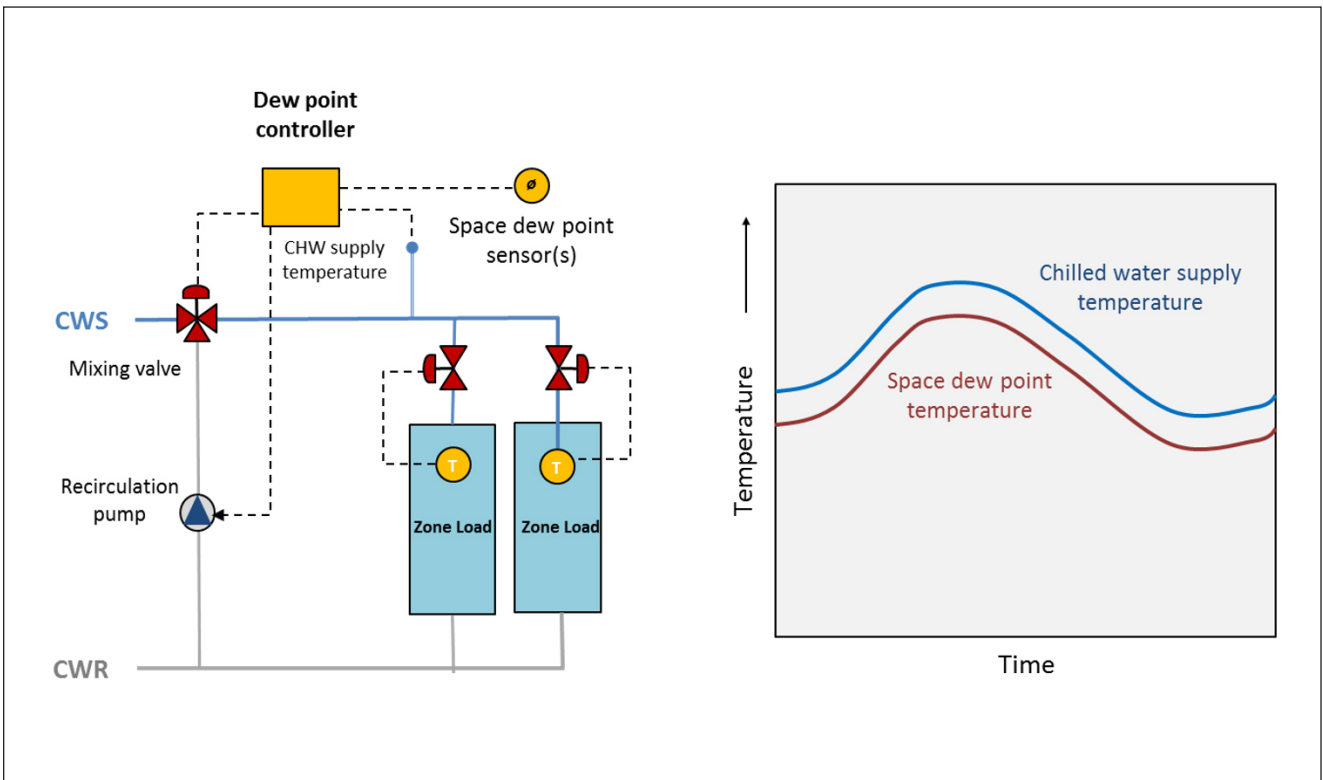

Figure 54: Condensation prevention by resetting the chilled water supply temperature

Other recommended condensation prevention practices

Good design practice should always involve the following common precautions:

- 1) *Chilled water pipes and valves should be sufficiently insulated.*
- 2) *Interfaces should be provided that shut off the chilled water circulation to zones when the air handling unit serving those zones is not running.*
- 3) *Chilled water supply temperatures should be maintained at or above the room operating dew point temperature.*
- 4) *In the case where the building HVAC systems are left off at night or on weekends, the air handling units should be programmed to deliver primary air to the space to stabilize its dew point temperature before the chilled water supply to the beams is activated.*
- 5) *Concealed surfaces of active beams applied with an open plenum return or used with low temperature primary air (supplied more than 3°F below the space design dew point temperature) should be insulated.*

Chapter 10 Installing and commissioning air-water systems

Where possible, the chilled beam system should be installed and connected prior to the installation of any acoustical ceiling system and/or drywall partitions. This will allow system start up without concern of piping system leaks. Each beam should be individually supported by hangers connected to the structural slab above the beam. The hanging system may be either threaded rods or cables but should be compliant with local building codes and seismic requirements. The beam manufacturer's installation and maintenance should be consulted for recommended support practices.

When beams are integrated into a ceiling grid system, the beam should be hung before the ceiling grid is installed and positioned 2½ to 3 inches (60 to 70 mm) above the plane of the finished ceiling. Beams should also have provisions that allow them to be moved a similar distance along their length and width access in order to facilitate their final positioning into the ceiling grid. When used in such an application, it is recommended that the final water connections to the beam are performed with flexible hose connectors. Oxygen diffusion resistant hoses should be used to prevent air from diffusing into the water system and creating corrosive conditions.

When connecting flexible hoses to the beam water coil, care must be taken to keep from overtightening the connection as doing so can result in leaks caused by breaking solder connections on the coil. It is also important that care is taken while handling the beam, coil connections should never be used as carriage points.

The primary airflow rate to the beam is determined by measuring the nozzle pressure and applying a factor provided by the manufacturer for the specific beam. This factor will be dependent on the beam's nozzle type,

length and configuration so it is important to identify the correct factor before beginning the air system balance. This factor can then be applied to the following equation to determine the beam's primary airflow rate:

$$CFM_{PA} = K \times P_{NOZZLE}^{.5}$$

Airflow rates estimated by this method are usually far more accurate than those derived by inlet duct traverses since the nozzle pressure is consistent throughout the beam and is typically 0.4 inches H2O or greater. Airflow measurement by conventional flow hoods is not recommended as the hood has a significant effect on induced airflow performance.

Titus offers self-powered mechanical airflow regulators that maintain a preset constant volume beam airflow rate regardless of changes in system pressure.

Provisions for measuring and balancing the water flow rates to the beams should be included. Hose kits that include Pete's plugs allow water side pressure drops to be measured and converted into water flow rates.

Chapter 11 Testing and rating of active beams

Testing and rating of air water systems

While chilled panels and beams were originally tested for water side sensible cooling capacity under EN Standards 14518 and 15116, ASHRAE Standard 200-2015 provides a method of test for active chilled beams that is the basis for the AHRI Certification program for active beams.

Titus chilled beams are tested and rated according to the ASHRAE Standard in our state of the art test chamber that is constructed and configured to comply with both ASHRAE and EU Standards. Certified performance in chilled water sensible cooling capacity, air and water side pressure loss, induction capacity and acoustics is verified by independent third party testing of randomly selected product samples.